



# Process Controller with Setpoint Programmer

1/16 DIN - 48 x 48



ISO 9001  
Certified

## M5 line

User Manual • M.I.U.M5-6/09.02 • Cod. J30-478-1AM5 IE



**Ascon Tecnologic srl**  
viale Indipendenza 56, 27029 Vigevano (PV)  
Tel.: +39-0381 69 871 - Fax: +39-0381 69 8730  
Sito internet: [www.ascontecnologic.com](http://www.ascontecnologic.com)  
Indirizzo E-Mail: [sales@ascontecnologic.com](mailto:sales@ascontecnologic.com)



# Process Controller with Setpoint Programmer

$\frac{1}{16}$  DIN - 48 x 48

## M5 line

---

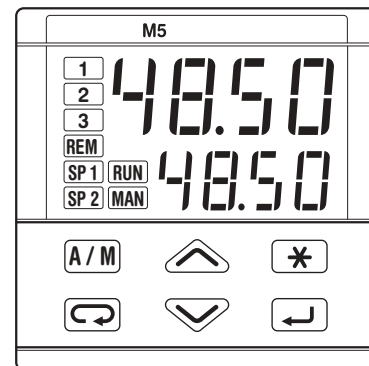



## NOTES

### ON ELECTRIC SAFETY AND ELECTROMAGNETIC COMPATIBILITY

**Please, read carefully these instructions before proceeding with the installation of the controller.**

**Class II instrument, real panel mounting.**

This controller has been designed with compliance to:

**Regulations on electrical apparatus** (appliance, systems and installations) according to the European Community directive 73/23/EEC amended by the European Community directive 93/68/EEC and the Regulations on the essential protection requirements in electrical apparatus EN61010-1 : 93 + A2:95.

**Regulations on Electromagnetic Compatibility** according to the European Community directive n089/336/EEC, amended by the European Community directive n° 92/31/EEC, 93/68/EEC, 98/13/EEC and the following regulations:

- Regulations on RF emissions  
EN61000-6-4 : 2001 industrial environments
- Regulation on RF immunity  
EN61000-6-2 : 2001 industrial equipment and system

**It is important to understand that it's responsibility of the installer to ensure the compliance of the regulations on safety requirements and EMC.**

The device has no user serviceable parts and requires special equipment and specialised engineers. Therefore, a repair can be hardly carried on directly by the user. For this purpose, the manufacturer provides technical assistance and the repair service for its Customers.

Please, contact your nearest Agent for further information.

**All the information and warnings about safety and electromagnetic compatibility are marked with the  sign, at the side of the note.**

# TABLE OF CONTENTS

<b>1</b>	<b>INTRODUCTION</b> .....	PAGE	4
	1.1 <b>PRODUCT CODING</b> .....	PAGE	5
<b>2</b>	<b>INSTALLATION</b> .....	PAGE	6
	2.1 <b>DESCRIPTION</b> .....	PAGE	6
	2.2 <b>OPERATING CONDITIONS</b> .....	PAGE	7
	2.3 <b>INSTALLATION</b> .....	PAGE	7
<b>3</b>	<b>ELECTRICAL CONNECTIONS</b> .....	PAGE	8
	3.1 <b>TERMINAL BLOCK</b> .....	PAGE	8
	3.2 <b>CABLING LAYOUT</b> .....	PAGE	8
	3.3 <b>ELECTRICAL CONNECTIONS</b> .....	PAGE	9
<b>4</b>	<b>OPERATIONS</b> .....	PAGE	15
	4.1 <b>FRONT PANEL</b> .....	PAGE	15
	4.2 <b>CONFIGURATION</b> .....	PAGE	16
	4.3 <b>PARAMETER SETTING</b> .....	PAGE	20
	4.4 <b>ACCESS LEVELS</b> .....	PAGE	27
<b>5</b>	<b>DISPLAYS</b> .....	PAGE	29
<b>6</b>	<b>COMMANDS</b> .....	PAGE	30
	6.1 <b>COMMANDS FROM KEYBOARD</b> .....	PAGE	31
	6.2 <b>COMMANDS FROM DIGITAL INPUTS</b> .....	PAGE	33
	6.3 <b>COMMANDS FROM SERIAL COMMUNICATION</b> (PLEASE, REFER THE ADDENDUM ON THE SERIAL COMMUNICATION)		-
<b>7</b>	<b>SETPOINT PROGRAMMER ( OPTIONAL )</b> .....	PAGE	34
	7.1 <b>PROGRAM ORGANISATION</b> .....	PAGE	34
	7.2 <b>OPERATING CONDITIONS</b> .....	PAGE	36
	7.3 <b>PROGRAM INPUT AND EDITING</b> .....	PAGE	37
	7.4 <b>RUN/STOP OF A PROGRAM</b> .....	PAGE	38
<b>8</b>	<b>TECHNICAL SPECIFICATIONS</b> .....	PAGE	39

# INTRODUCTION

Congratulations for having chosen these universal controllers. They are the best result of our experience in designing and manufacturing of smart, powerful and high reliable controllers.

## POWERFUL FEATURES AND A WIDE RANGE OF FUNCTIONALITIES

The process controllers of the M5 series have been designed for the industrial environment, are provided with a complete set of functions, as a true universal instrument.

They can be used as Controllers-Programmers with 1 Setpoint profile of 16 segments.

### Resources

**Main universal input**

6 TC, Pt100, ΔT, mA V, Custom PV

**Auxiliary input (option)**

POT., REM mA, REM V, AUX

**Two digital inputs**

IL1, IL2



M5

**Memory Chip**  
Data Copy/Data Store (option)

**Modbus RS485**  
Parameterisation Supervision (option)



**Setpoint**

LOC, 2 MEM, REM, 1x16s

**Digital inputs (IL1, IL2) functions**

2 MEM, REM, RUN, HOLD PV, SP LOCK

### Operating mode

	Control	Alarms			Retransmission
					
	PV/SP				
1 Single action	OP1		OP2	OP3	OP4
2 Single action		OP4	OP1	OP2	OP3
3 Double action	OP1	OP2			OP3
4 Double action	OP1	OP4		OP2	OP3
5 Double action	OP4	OP2	OP1		OP3
6 Valve	OP1	OP2		OP3	OP4

**Tuning**

One shot, Adaptive, Auto tuning

**1.1 PRODUCT CODING**

The complete code is displayed on the instrument label.

The information about product coding are accessible from the front panel by mean of a particular procedure described at section 5.1 pag 29

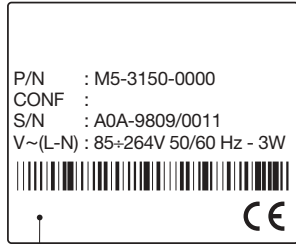

Instrument label

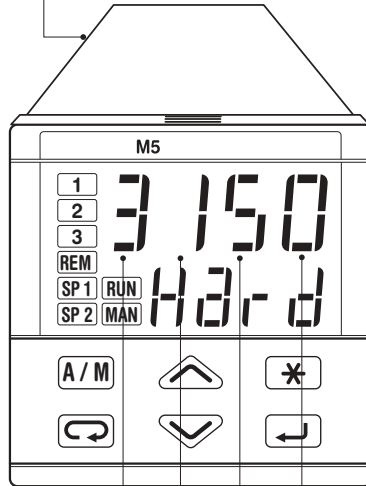

**A B C D**  
Basic product code

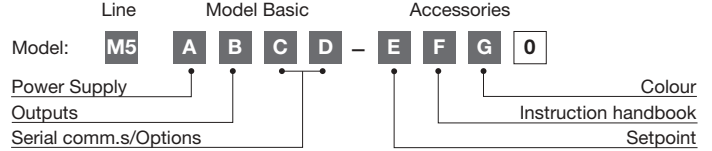

Power Supply	A
100...240Vac (-15...+10%)	3
24Vac (-25...+12%) or 24Vdc (-15...+25%)	5

Outputs OP1 (OP2)	B
Relay - Relay	1
Relay - Triac	2
Triac - Relay	4
Triac - Triac	5

Serial Comms.	Options	C	D	
Not fitted	None [2]	0	0	
	Auxiliary Input	Feedback potentiometer [2]	0	1
		Remote Setpoint [1]	0	2
	Auxiliary Output	Current Transformer	0	3
SSR drive/analogue		0	4	
RS485 Modbus/Jbus protocol	SSR drive/analogue + Remote Setpoint [1] [2]	0	5	
	None [2]	5	0	
	Auxiliary Input	Feedback potentiometer [2]	5	1
		Remote Setpoint [1]	5	2
SSR drive/analogue auxiliary output	Current Transformer	5	3	
		5	4	

[1] Not available with Setpoint programmer installed (E = 1)  
[2] Second digital input (IL2) not available

Setpoint Programmer	E
Not fitted	0
Fitted	1

Front panel Colour	G
Dark (std)	0
Beige	1

Instruction handbook	F
Italian-English (std.)	0
French-English	1
German-English	2
Spanish-English	3

## 2 INSTALLATION

**Installation must only be carried out by qualified personnel.**

Before proceeding with the installation of this controller, follow the instructions illustrated in this manual and, particularly the installation precautions marked with the  symbol, related to the European Community directive on electrical protection and electromagnetic compatibility.



To prevent hands or metal touching parts that may be electrically live, the controllers must be installed in an enclosure and/or in a cubicle.

### 2.1 INSTALLATION DESCRIPTION

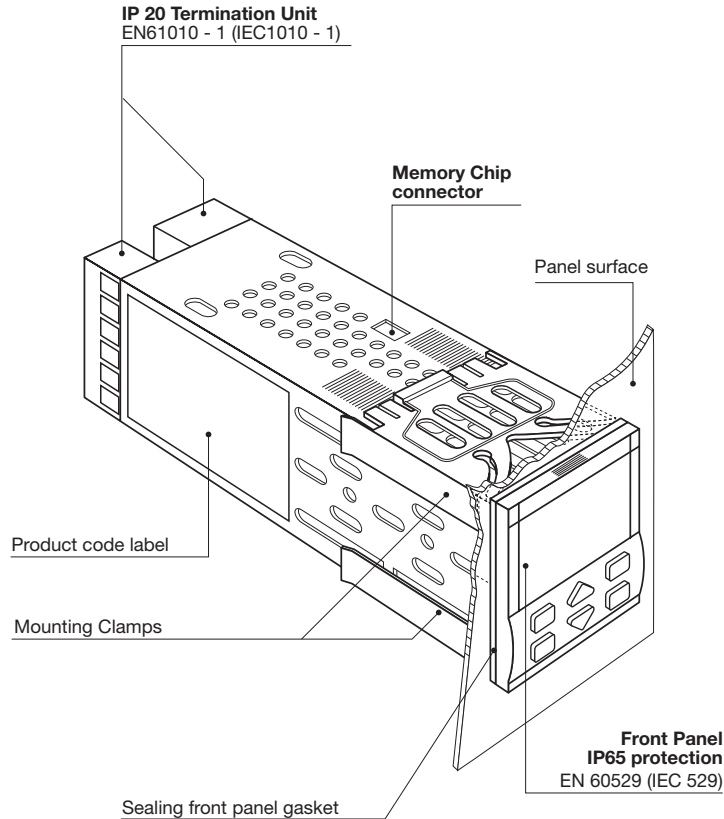

### 2.1.1 DIMENSIONAL DETAILS

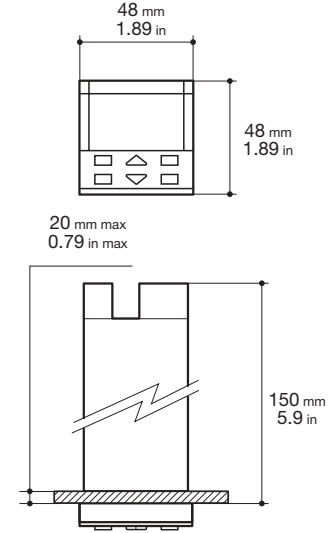

### 2.1.2 PANEL CUT-OUT

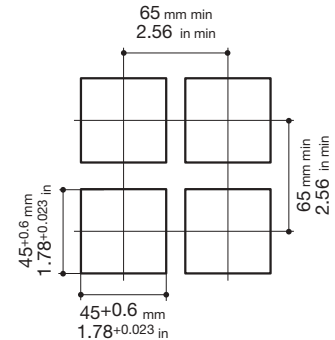

## 2.2 ENVIRONMENTAL RATINGS



### Operating Conditions



Altitude up to 2000 m



Operating surrounding temperature 0...50°C [1]

%Rh

Relative Humidity 5...95 %Rh non-condensing

### Special Conditions



Altitude > 2000 m

Use 24Vac supply version



Temperature >50°C

Use forced air ventilation

%Rh

Humidity > 95 %Rh

Warm up



Conducting atmosphere

Use filters

### Forbidden Conditions



Corrosive atmosphere



Explosive atmosphere

### UL notes

[1] Operating surrounding temperature 0...50°C

[2] For Use on a Flat Surface of a Type 2 and Type 3 'raintight' Enclosure.

## 2.3 PANEL MOUNTING [2]

### 2.3.1 INSERT THE INSTRUMENT

- 1 Prepare panel cut-out
- 2 Check front panel gasket position
- 3 Insert the instrument through the cut-out

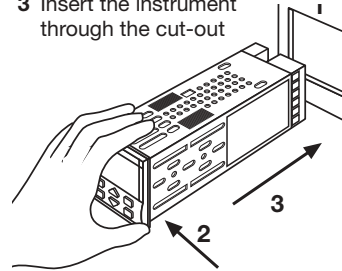

### 2.3.2 INSTALLATION SECURING

- 1 Fit the mounting clamps
- 2 Push the mounting clamps towards the panel surface to secure the instrument

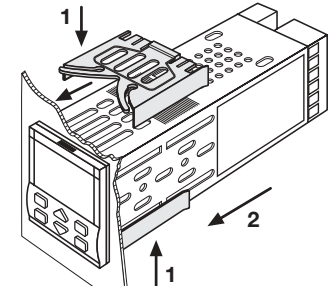

### 2.3.3 CLAMPS REMOVING

- 1 Insert the screwdriver in the clips of the clamps
- 2 Rotate the screwdriver

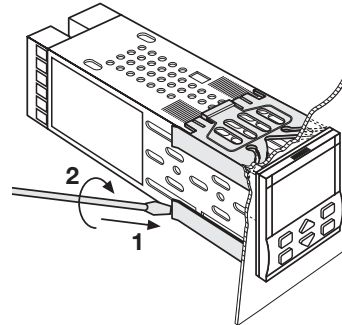

### 2.3.4 INSTRUMENT UNPLUGGING



- 1 Push and
  - 2 Pull to remove the instrument
- Electrostatic discharges can damage the instrument  
Before removing the instrument the operator must discharge himself to ground

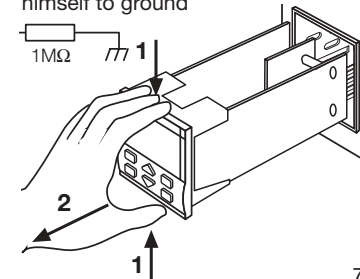



# 3 ELECTRICAL CONNECTIONS

## PRECAUTIONS



Despite the fact that the instrument has been designed to work in an harsh and noisy environmental (level IV of the industrial standard IEC 801-4), it is strongly recommended to follow the following suggestions.



All the wiring must comply with the local regulations.

The supply wiring should be routed away from the power cables.

Avoid to use electromagnetic contactors, power relays and high power motors nearby.

Avoid power units nearby, especially if controlled in phase angle

Keep the low level sensor input wires away from the power lines and the output cables.

If this is not achievable, use shielded cables on the sensor input, with the shield connected to earth.

## UL notes

[1] Use 60/70 °C copper (Cu) conductor only.

[2] Wire size 1 mm<sup>2</sup> (18 AWG Solid/Stranded)

## 3.1 TERMINAL BLOCK [1]

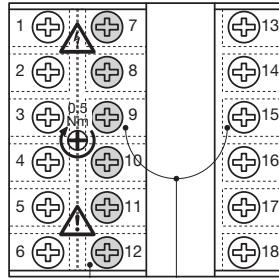

Rear terminal covers

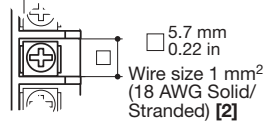

18 screw terminals M3



Option terminals



Holding screw 0.5 Nm



Phillips screw driver PH1



Flat blade screw driver 0.8 x 4 mm

## Terminals



Pin connector  $\varnothing$  1.4 mm  
0.055 in max



Fork-shape AMP 165004  
 $\varnothing$  5.5 mm - 0.21 in



Stripped wire  
L 5.5 mm - 0.21 in

## 3.2 RECOMMENDED WIRE ROUTING

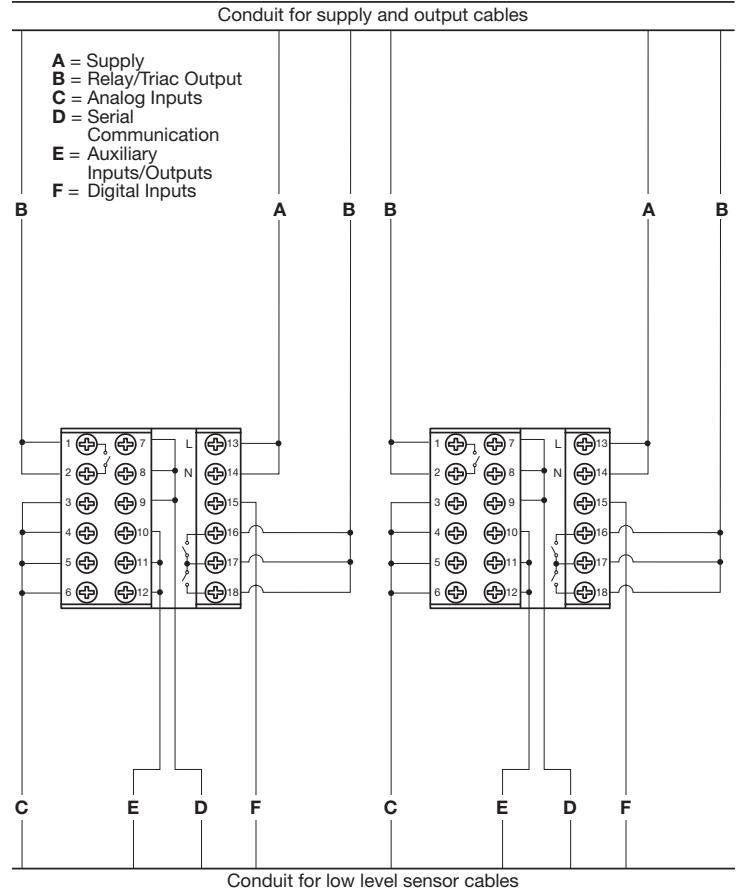



### 3.3 TYPICAL INSTRUMENT WIRING (valve control)

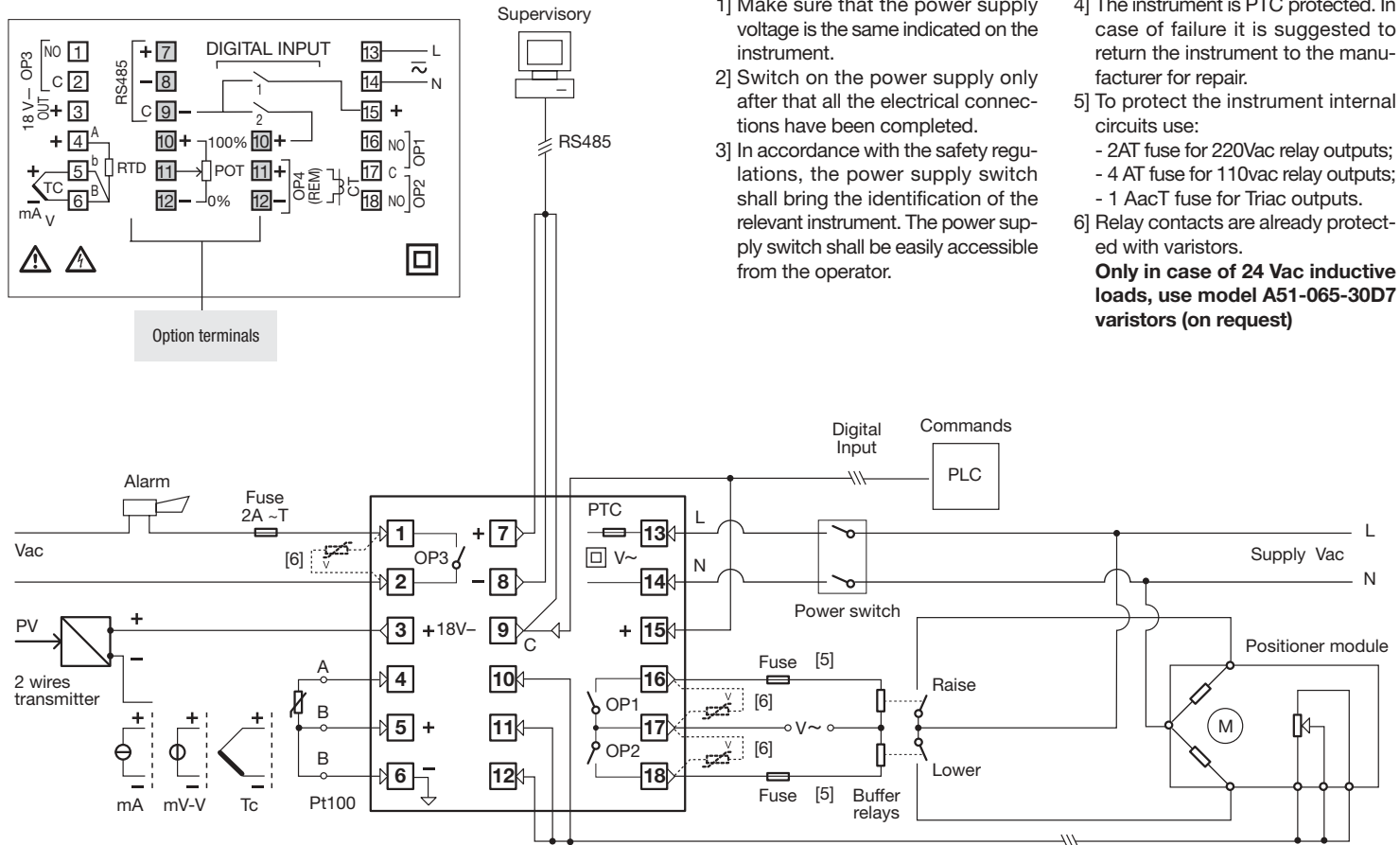

#### Notes:

- 1] Make sure that the power supply voltage is the same indicated on the instrument.
- 2] Switch on the power supply only after that all the electrical connections have been completed.
- 3] In accordance with the safety regulations, the power supply switch shall bring the identification of the relevant instrument. The power supply switch shall be easily accessible from the operator.
- 4] The instrument is PTC protected. In case of failure it is suggested to return the instrument to the manufacturer for repair.
- 5] To protect the instrument internal circuits use:
  - 2AT fuse for 220Vac relay outputs;
  - 4 AT fuse for 110vac relay outputs;
  - 1 AAcT fuse for Triac outputs.
- 6] Relay contacts are already protected with varistors.
 

**Only in case of 24 Vac inductive loads, use model A51-065-30D7 varistors (on request)**

## 3.3.1 POWER SUPPLY

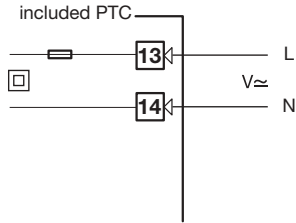

Switching power supply with multiple isolation and internal fuse

- **Standard version:**  
nominal voltage:  
100...240Vac (-15...+10%)  
Frequency 50/60Hz
- **Low Voltage version:**  
Nominal voltage:  
24Vac (-25...+12%)  
Frequency 50/60Hz  
or 24Vdc (-15...+25%)
- Power consumption 3W max.

## 3.3.2 PV CONTROL INPUT

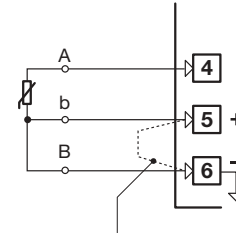
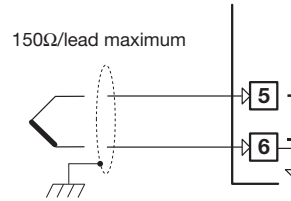

When using a 2 wire system, put a jumper between terminals 5 and 6

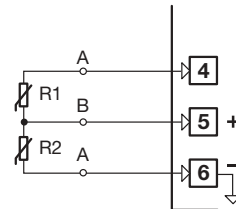
**A For JLT KSR thermocouple type**

- Use always compensation cable of the correct type for the thermocouple used
- Use always compensation cable of the correct type for the thermocouple used
- The shield, if present, must be connected to a proper earth.

**B For PT100 resistance thermometer**

- If a 3 wire system is used, use always cables of the same diameter (1mm<sup>2</sup> min).  
Maximum resistance/line 20 Ω
- If a 2 wire system is used, use always cables of the same diameter (1.5mm<sup>2</sup> min).

⚠ When the distance between the controller and the sensor is 15 meters, using a cable of 1.5mm<sup>2</sup> diameter, produces an error in the measure of 1°C.

**B1 For ΔT (2x Pt100)**

- Use wires of the same length.  
Maximum resistance/line 20 Ω.

**R1 + R2 must be <320Ω**

## 3.3.2 PV CONTROL INPUTS (cont.)

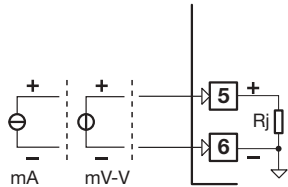
**C For DC input**

Input resistance =  $30\Omega$  for mA  
 Input resistance =  $10M\Omega$  for mV  
 Input resistance =  $10k\Omega$  for Volt

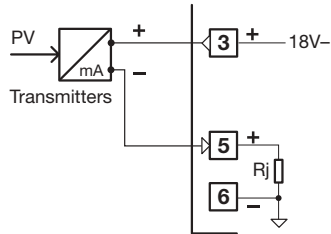
**C1 For 2 wires transmitters**

- Power supply to the transmitter  
 $18Vdc \pm 10\%$   
 $30mA$  max.  
 Input resistance =  $30\Omega$

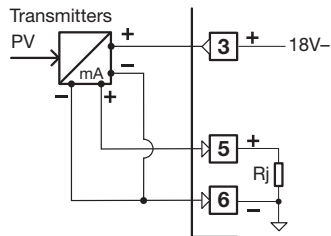
**C2 For 3 or 4 wires transmitters**

- Power supply to the transmitter  
 $18Vdc \pm 10\%$   
 $30mA$  max.  
 Input resistance =  $30\Omega$

## 3.3.3 AUXILIARY INPUTS (OPTION)

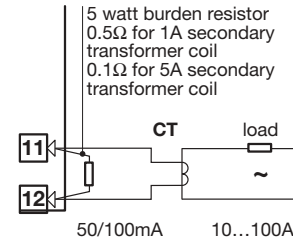
**A For current transformer CT**  
for the measure of the load current

- Primary coil 10A...100A
- Secondary coil 50 mA default  
 $100mA$  jumper selectable

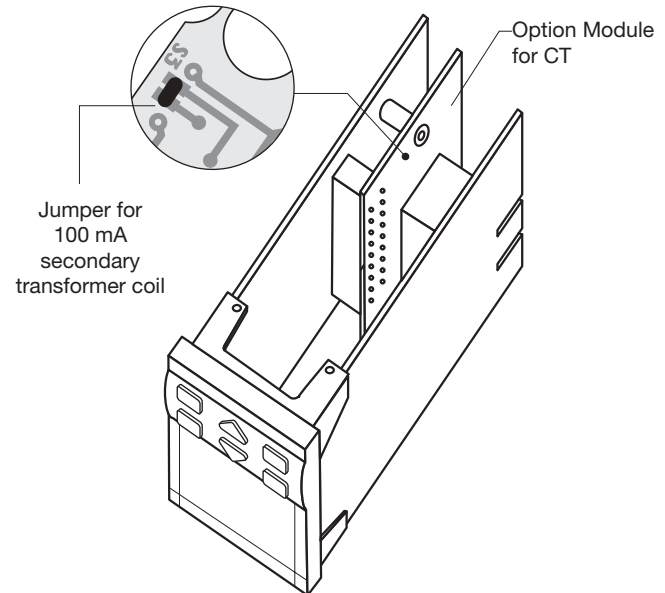

### 3.3.3 AUXILIARY INPUTS (cont.)



△ If the analogue input is provided, the terminals for the Remote Setpoint are 10(+) and 9(-)

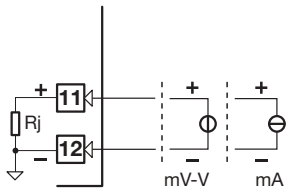

#### B From Remote Setpoint

Current  
0/4...20mA  
Input resistance = 30Ω

Voltage  
1...5V, 0...5V, 0...10V  
Input resistance = 300kΩ

#### C From Position Potentiometer

To read the real position of the motor or the valve

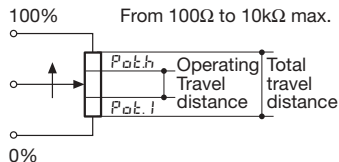
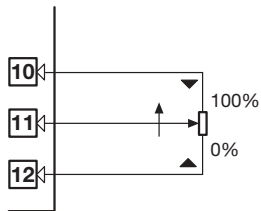

### 3.3.4 DIGITAL INPUTS

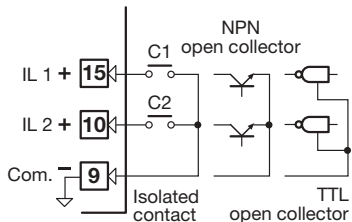

- The associated function is active when the digital input is ON (see table on page 33)
- The second digital input (IL2) is available only with the following options:  
Remote Setpoint (D = 2)  
Current transformer (D = 3)  
SSR drive / analogue output (D = 4)

### 3.3.5 OP1 OP2 OP3 AND OP4 OUTPUTS



The functionality associated to each of the OP1 OP2 OP3 and OP4 outputs is defined during the configuration of the instrument. The possible choices are:

		Control		Alarms			Retransm. PV-SP
1	Single action	OP1 Heat			OP2	OP3	OP4-C
2	Single action	OP4 Heat		OP1	OP2	OP3	
3	Double action	OP1 Heat	OP2 Cool			OP3	OP4-C
4	Double action	OP1 Heat	OP4 [1] Cool		OP2 [2]	OP3	
5	Double action	OP4 [1] Heat	OP2 Cool	OP1 [2]		OP3	
6	Valve	OP1 Raise	OP2 Lower			OP3	OP4-C

where:

<b>OP1 - OP2</b>	Relay or Triac output
<b>OP3</b>	Relay output
<b>OP4</b>	Analogue or SSR drive output
<b>OP4-C</b>	Analogue output

#### Notes

- [1] In case of OP4 analogue output, its status is not visualised by any red led  
[2] When the OP4 SSR drive output is selected, the status of OP1 and OP2, as alarms, is not displayed by any red led

**3.3.5-A SINGLE RELAY OUTPUT (TRIAC)**

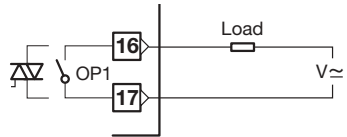

1 NO contact

**3.3.5-B SINGLE SSR DRIVE OUTPUT (OPTION)**

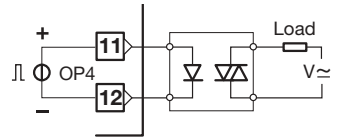

Output 0...22Vdc ±20% (20mA max.)  
galvanic isolated

**3.3.5-F HEAT COOL OUTPUT RELAY (TRIAC)/SSR DRIVE (OPTION)**

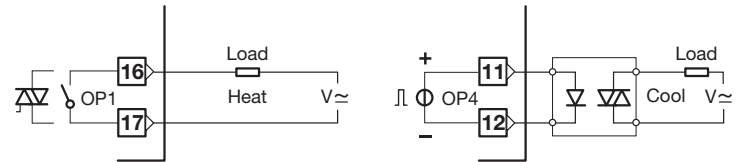

**3.3.5-C SINGLE ANALOGUE OUTPUT (OPTION)**

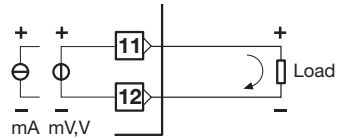

galvanic isolated  
500 Vac/ 1min  
750Ω / 15V max. if current output  
500Ω / 20mA max. if voltage output

**3.3.5-D VALVE OUTPUT**

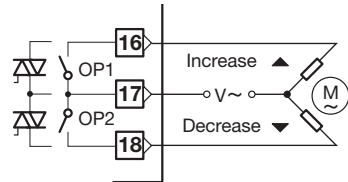

3 pole output with NO contacts  
(increase, decrease, stop)

**3.3.5-G HEAT COOL OUTPUT SSR DRIVE (OPTION)/RELAY (TRIAC)**

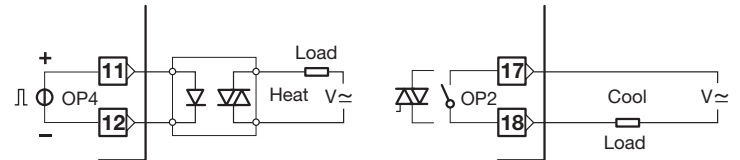

**3.3.5-E HEAT COOL OUTPUT RELAY/RELAY (TRIAC/TRIAC)**

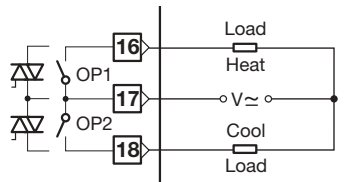

2 NO contacts

**3.3.5-H HEAT COOL OUTPUT RELAY (TRIAC)/ANALOGUE (OPTION)**

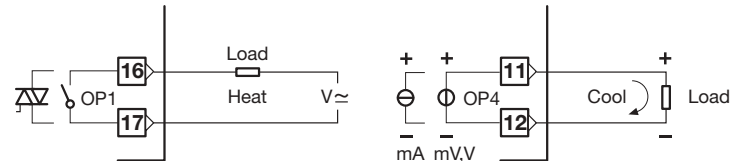

**3.3.5-I HEAT COOL OUTPUT DC (OPTION)/RELAY (TRIAC)** 

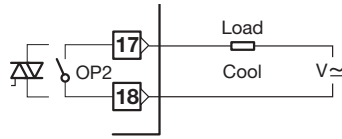
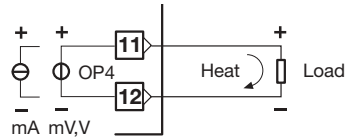

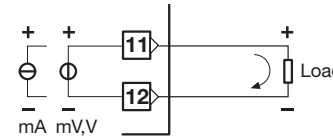

**3.3.7 RETRANSMISSION OUTPUT (OPTION)** 

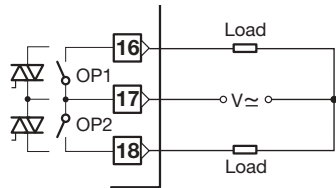

Output \with galvanic isolation of 500 Vac/ 1min  
750Ω / 15V max. if current output  
500Ω / 20mA max. if voltage output  
 **The analogue/SSR drive output OP4 can be used for signal retransmission only if it is not used as control output.**

**3.3.6 ALARM OUTPUTS OP1, OP2, OP3** 



 **The relay/triac output OP1, OP2 and OP3, can be used as alarm outputs only if they are not used as control outputs.**

2 NO contacts

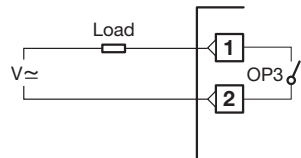

1 NO contact

**3.3.8 SERIAL COMMUNICATION (OPTION)** 

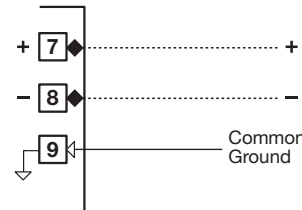

- Galvanic isolation 500Vac/1 min  
Compliance to the EIA RS485 standard for Modbus/Jbus

 Please, read: **gamma<sup>due</sup>**® and **delta<sup>due</sup>**® controller series serial communication and configuration

# 4 OPERATION

## 4.1.A KEYS FUNCTION AND DISPLAY IN OPERATOR MODE

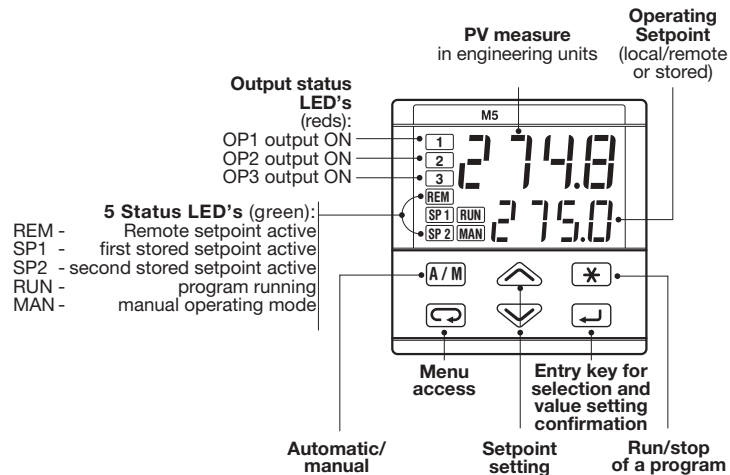

## 4.1.B KEYS FUNCTION AND DISPLAY IN PROGRAMMING MODE

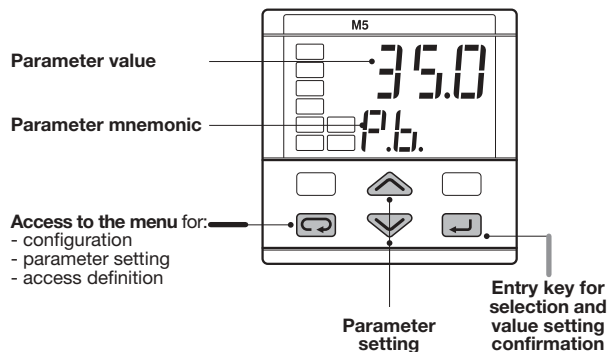

## 4.1.1 NUMERIC ENTRY

(i.e. the modification of the value of a stored Setpoint from 275.0 to 240.0)

Press or momentarily to change the value of 1 unit every push. Continued pressing of or changes the value, at rate that doubles every second. Releasing the button the rate of change decreases. In any case the change of the value stops when it has reached the max/min limit set for the parameter.

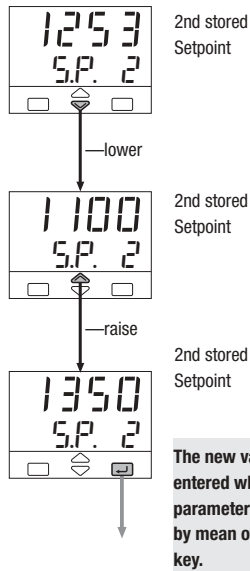

## 4.1.2 MNEMONIC SETTING

(Way to modified configuration page 16 / 18)

Press the or to display the next or previous mnemonic for the selected parameter. Continued pressing of or will display further mnemonics at a rate of one mnemonic every 0.5 seconds. The mnemonic displayed at the time the next parameter is selected, is the one stored in the parameter.

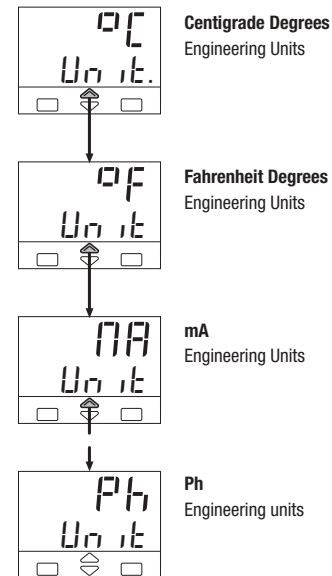



## 4.2 CONFIGURATION PROCEDURE

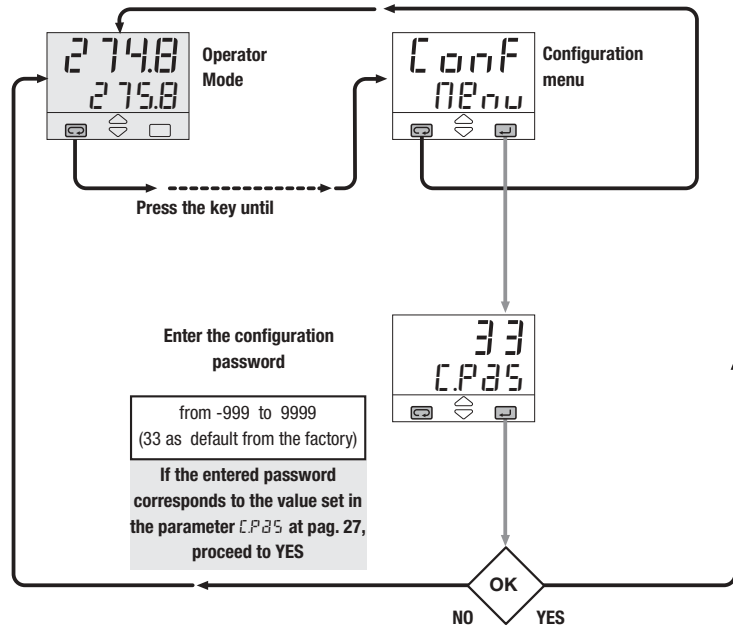

If the configured hardware option is not installed, the display shows an hardware error message



100	Analog output not installed
101	Current transformer not installed
102	Remote Setpoint input not installed
103	Potentiometer input not installed
104	Analogue output + Remote Setpoint not installed

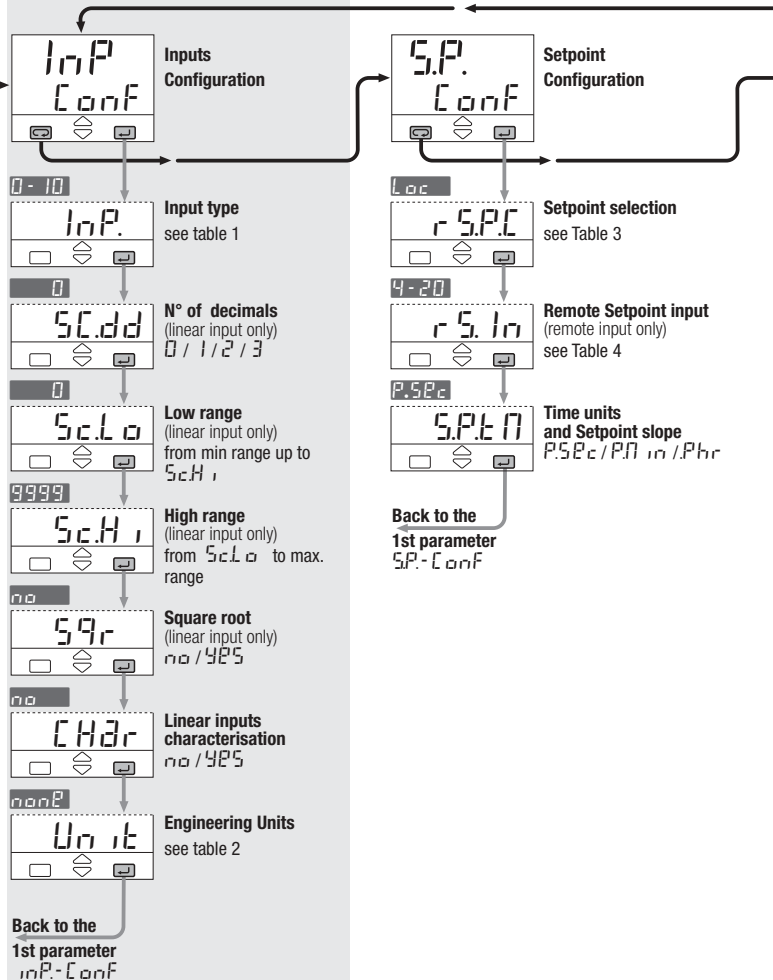

## CONFIGURATION MENU

**Out Conf**  
Output Configuration

**Out Conf**  
Type of Control  
see Table 5

OFF

0.14

**Out Conf**  
Heat control output  
see Table 6

OFF

H.COP

**Out Conf**  
Control output safety value  
OFF / -100...100%

OFF

5.0ut

**Out Conf**  
Retransmission output  
(available for DC output only)  
none / PU / SP.

none

rth

**Out Conf**  
Retransmission output type  
(available for DC output only)  
see Table 4

4-20

0.rty

**Out Conf**  
Retransmission low range  
whole range

0

rthlo

**Out Conf**  
Retransmission high range  
whole range

9999

rthh

**Out Conf**  
Cool control output  
see Table 7

OFF

C.COP

**LinP Conf**  
Digital inputs configuration

**LinP Conf**  
IL1 function  
see Table 8

OFF

IL1

**LinP Conf**  
IL2 function  
see Table 8

OFF

IL2

Back to the  
1st parameter of  
LinP - Conf

**ALN Conf**  
Alarm s configuration

**ALN Conf**  
AL1 alarm type  
see Table 9

OFF

AL1

**ALN Conf**  
AL1 addressing  
(not available when AL1 is OFF)  
OP1 / OP2 / OP3

OP1

A10w

**ALN Conf**  
AL1 latching  
(not available when AL1 is OFF)  
no / YES

no

Ltch

**ALN Conf**  
AL1 start-up disabling  
(not available when AL1 is OFF)  
no / YES

no

bloc

**ALN Conf**  
AL2 alarm type  
see Table 9

OFF

AL2

**ALN Conf**  
AL2 addressing  
(not available when AL2 is OFF)  
OP1 / OP2 / OP3

OP1

A20w

**ALN Conf**  
AL2 latching  
(not available when AL2 is OFF)  
no / YES

no

Ltch

**ALN Conf**  
AL2 start-up disabling  
(not available when AL2 is OFF)  
no / YES

no

bloc

AL3 alarm type  
see Table 9

AL3 alarm type  
(not available when AL3 is OFF)  
OP1 / OP2 / OP3

AL3 latching  
(not available when AL3 is OFF)  
no / YES

AL3 start-up disabling  
(not available when AL3 is OFF)  
no / YES

AL4 alarm type  
see Table 9

AL4 addressing  
(not available when AL4 is OFF)  
OP1 / OP2 / OP3

AL4 latching  
(not available when AL4 is OFF)  
no / YES

AL4 start-up disabling  
(not available when AL4 is OFF)  
no / YES

Back to the 1st parameter of Out - Conf

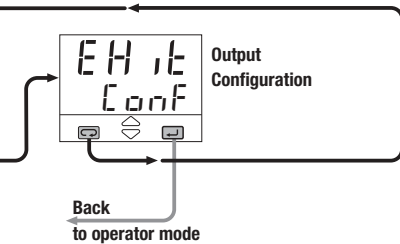

Tab. 1 Input type		
Value	Description	InP.
tc.d	0...600°C	32...1112°F
tc.l	0...600°C	32...1112°F
tc.l	0...1200°C	32...2192°F
tc.s	0...1600°C	32...2912°F
tc.r	0...1600°C	32...2912°F
tc.t	-200...400°C	-328...752°F
cus	Custom range on request	
rt.d1	-200...600°C	-328...1112°F
rt.d2	-99.9...300.0°C	-99.9...572.0°F
dP.Lt	-50.0...50.0°C	-58.0...122.0°F
PU	0...50 mV	Engineering units
0-5	0...5 Volt	
1-5	1...5 Volt	
0-10	0...10 Volt	
0-20	0...20 mA	
4-20	4...20 mA	

Tab. 2 Engineering units		
Value	Description	Unit
none	None	
°C	Centigrade Degrees	
°F	Fahrenheit Degrees	
mA	mA	
mV	mV	
V	Volt	
bar	bar	
PSI	PSI	
Rh	Rh	
Ph	Ph	

Tab. 3 Setpoint type		
Value	Description	r.SP.
Loc	Local only	
rem	Remote only	
L-r	Local/remote only	
Loc.t	Local - trim	
rem.t	Remote - trim	

Tab. 4 Rem. Setpoint Retransmission		
Value	Description	r.S.In
0-5	0...5 Volt	Or.t.Y
1-5	1...5 Volt	
0-10	0...10 Volt	
0-20	0...20 mA	
4-20	4...20 mA	

Tab. 5 Control type		
Value	Description	Or.t.Y
DF.rP	Reverse action	On - Off
DF.d1	Direct action	
P.dd	Direct action	P.I.D.
P.dr	Reverse action	
U.d.r	Direct action	Modulating valves
U.r.PU	Reverse action	
HCLn	Linear	Heat/Cool
H.C.O.L	Oil charac.	
H.C.H.2	Water charac.	

Tab. 6 Heat control output		
Value	Description	H.C.O.P
OFF	Not used	Digital signal
r.1	Relay 1	
L.o.g	SSR drive	Analogue signal
0-5	0...5 Volt	
1-5	1...5 Volt	
0-10	0...10 Volt	
0-20	0...20 mA	
4-20	4...20 mA	

Tab. 7 Cool control output		
Value	Description	C.C.O.P
OFF	not used	Digital signal
r.2	relay 2	
L.o.g	SSR drive	Analogue signal
0-5	0...5 Volt	
1-5	1...5 Volt	
0-10	0...10 Volt	
0-20	0...20 mA	
4-20	4...20 mA	

Tab. 8 Digital Inputs function		
Value	Description	IL1
OFF	Not used	IL2
L-r	Local/remote	
Auto	Auto/manual	
SP.1	1st stored Setpoint	
SP.2	2nd stored Setpoint	
PE.b.1	Keypad	
SL.o.1	SP. slope disable	
HPU	Measure hold	
r-H	Run/stop of a program	

Tab. 9 Alarm type			
Value	Description	AL1	AL2
OFF	Not used	AL3	AL4
F5.H	Active high	Absolute	
F5.L	Active low		
dP.U.H	Active high	Deviation	
dP.U.L	Active low		
b.d.n.d	Out active	Band	
Ht.r	Active high	Heater Break	
L.b.d	Loop break alarm (AI1 only)		

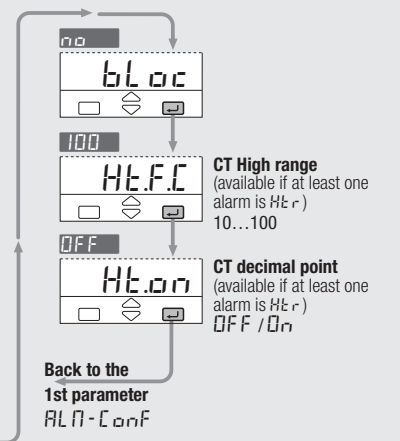

### 4.2.1 AL1, AL2, AL3, AL4 ALARMS CONFIGURATION

It is possible to configure up to 4 alarms: AL1, AL2, AL3, AL4 (see pag. 17), selecting, for each of them:

- A** the type and the operating condition of the alarm (table 9 page 18)
- B** the functionality of the alarm acknowledgement (latching)  $\overline{L L C H}$
- C** the start-up disabling (blocking)  $\overline{B L D C}$
- D** the physical output of the alarm  $\overline{O P 1} \overline{O P 2} \overline{O P 3}$

**The outputs can be used for alarms if they are not used as control outputs (see par. 3.3.5 page 12)**

It is possible to route up to 4 alarm to a single output (OR of the alarms).

#### Alarm occurrence display

This function can be enabled by the configuration software. (please read the user instruction on the "M5 LINE MODBUS /JBUS PROTOCOL", supplied separately)

The type of alarm is presented flashing, on the front panel in alternation with the PV value.



The red led of the activated alarm output is on.

The range of the alarm threshold correspond to the whole span and it is not limited by the SP Setpoint span.

#### [A] OPERATING CONDITIONS

##### Absolute alarm

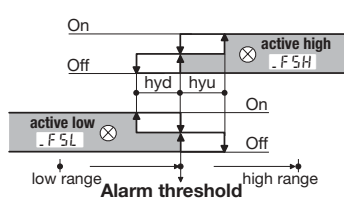

##### Deviation alarm

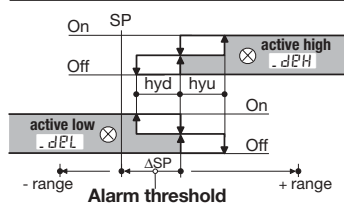

##### Band alarm

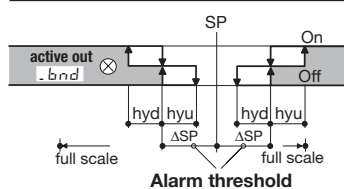

#### [B] ALARM ACKNOWLEDGE FUNCTION

The alarm, once occurred, is presented on the display until to the time of acknowledge. The acknowledge operation consists in pressing any key.

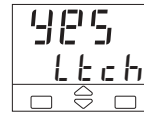

After this operation, the alarm leaves the alarm state only when the alarm condition is no longer present.

#### [C] START-UP DISABLING

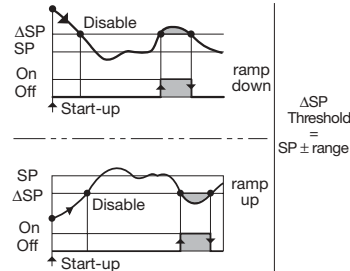
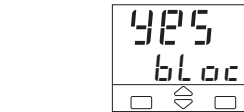

#### [D] LOOP BREAK ALARM LBA

When the controller connection to the sensor is discontinued or other faults are detected in the control loop, the AL1 alarm becomes active, after a predefined time of 1 to 9999 s, from the detection of the failure.

The alarm state ceases when the fault condition is no longer present.

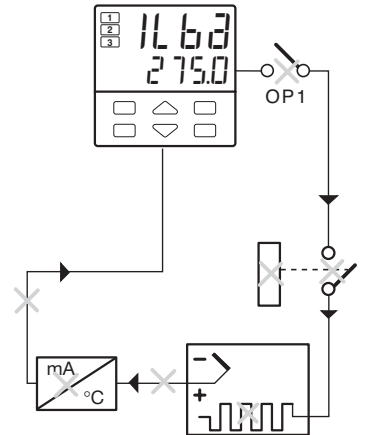

**⚠ In case of ON-OFF control, the LBA alarm is not active.**

### 4.3 PARAMETER SETTING

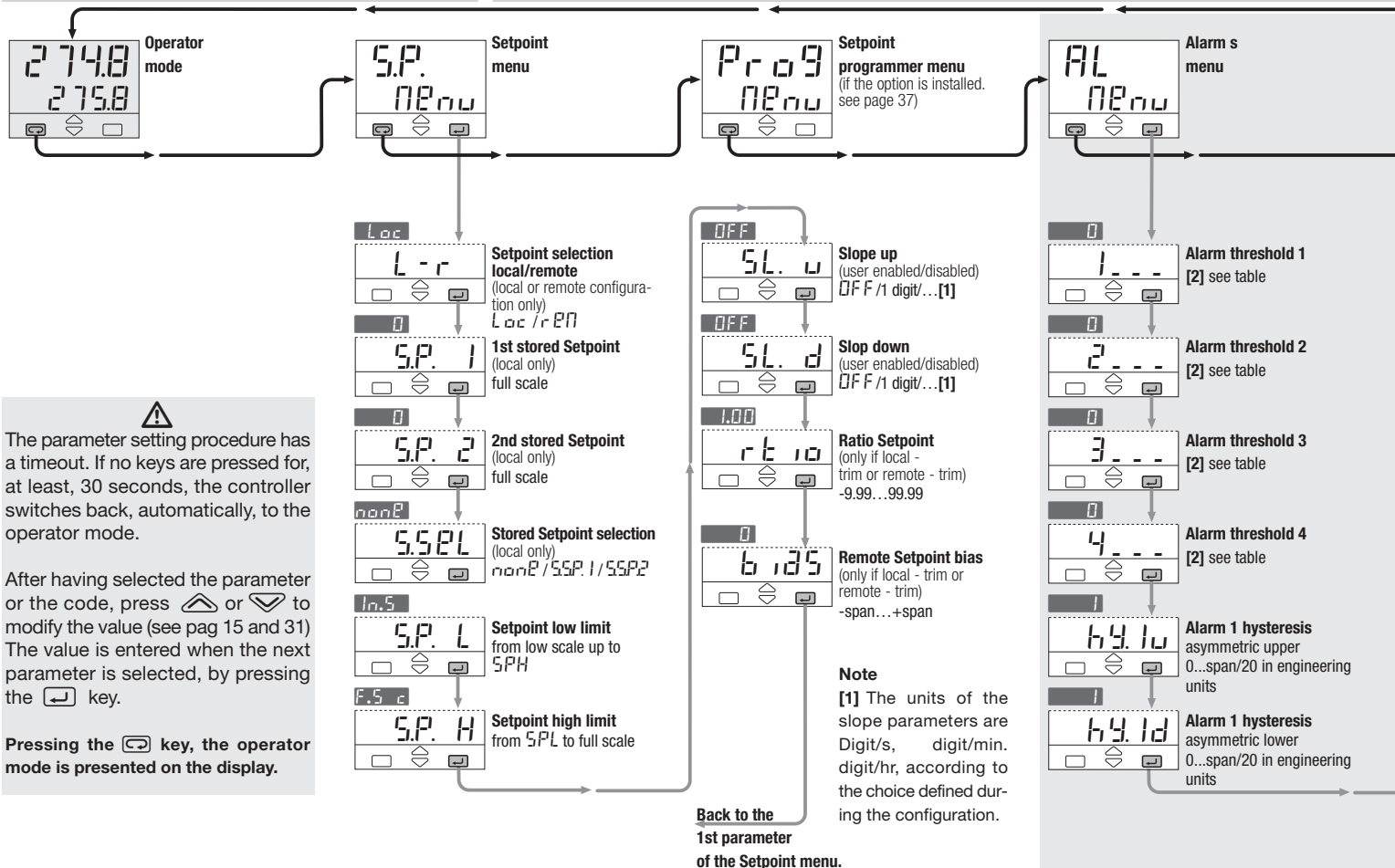

**⚠**  
The parameter setting procedure has a timeout. If no keys are pressed for, at least, 30 seconds, the controller switches back, automatically, to the operator mode.

After having selected the parameter or the code, press  $\uparrow$  or  $\downarrow$  to modify the value (see pag 15 and 31). The value is entered when the next parameter is selected, by pressing the  $\rightarrow$  key.

Pressing the  $\leftarrow$  key, the operator mode is presented on the display.

PARAMETER MENU

1

64.2u Alarm 2 hysteresis asymmetric upper  
0...span/20 in engineering units

2

64.2d Alarm 2 hysteresis asymmetric lower  
0...span/20 in engineering units

3

64.3u Alarm 3 hysteresis asymmetric upper  
0...span/20 in engineering units

4

64.3d Alarm 3 hysteresis asymmetric lower  
0...span/20 in engineering units

5

64.4u Alarm 4 hysteresis asymmetric upper  
0...span/20 in engineering units

6

64.4d Alarm 4 hysteresis asymmetric lower  
0...span/20 in engineering units

Back to the 1st parameter of the Alarms menu.

P.I.D. menu

P Id

no

5.0

P.b. Proportional band (P.I.D. algorithm only)  
0.5...999.9 % of span

60

t.i. Integral time (user enabled/disabled) (P.I.D. algorithm only)  
0FF/1...9999 seconds

**Note [2]** A code, specifying the n° and the alarm type that has been configured, is displayed. At this point, the user must enter the threshold value, according to the following table.

Type and value	Mode	N° and Param.
Absolute	Active high	-FSH
	Active low	-FSL
Deviation	Active high	-dEH
	Active low	-dEL
Band full scale	Active out of band	-bnd
Load Threshold 1...100A 0.1...20A	Active high	-Htr
	Active high	ILb2
AL1 activation delay 1...9999 s	Active high	ILb2

12.0

t.d. Derivative time (user enabled/disabled) (P.I.D. algorithm only)  
0FF/0.1...999.9 seconds

0FF

dErr Error dead band  
0FF/0.1...10.0 digit

1.00

O.C. Overshoot control (user enabled/disabled) (P.I.D. algorithm only)  
0.01...1.00

50

PrES Manual reset (user enabled/disabled) (P.I.D. algorithm only)  
0FF/1...100% output

5.0

P.b.C Proportional band Cool channel (Heat/Cool configuration only)  
0.1...999.9% full scale

60

t.i.C Cool Integral time (user enabled/disabled) (Heat/Cool configuration only)  
0FF/1...9999 seconds

12.0

t.d.C Cool Derivative time (user enabled/disabled) (Heat/Cool configuration only)  
0FF/0.1...999.9 seconds

Back to the 1st parameter of the P.I.D. menu

Tuning menu

tune

no

no

tune Initial Tune start (one shot tune)  
no/425

no

AdPt Continuous Tune start (adaptive tune) (not available with set PrCh)  
no/425.

P.b.

Calculated Proportional band [3] (display only) (available when adaptive tune is selected)

t.i.

Calculated Integral time [3] (display only) (available when adaptive tune is selected)

t.d.

Calculated derivative time [3] (display only) (available when adaptive tune is selected)

**Nota [3]**  
These values are not automatically stored on the P.I.D. menu parameters P.b., t.i., t.d.

Back to the 1st parameter of the Tuning menu.

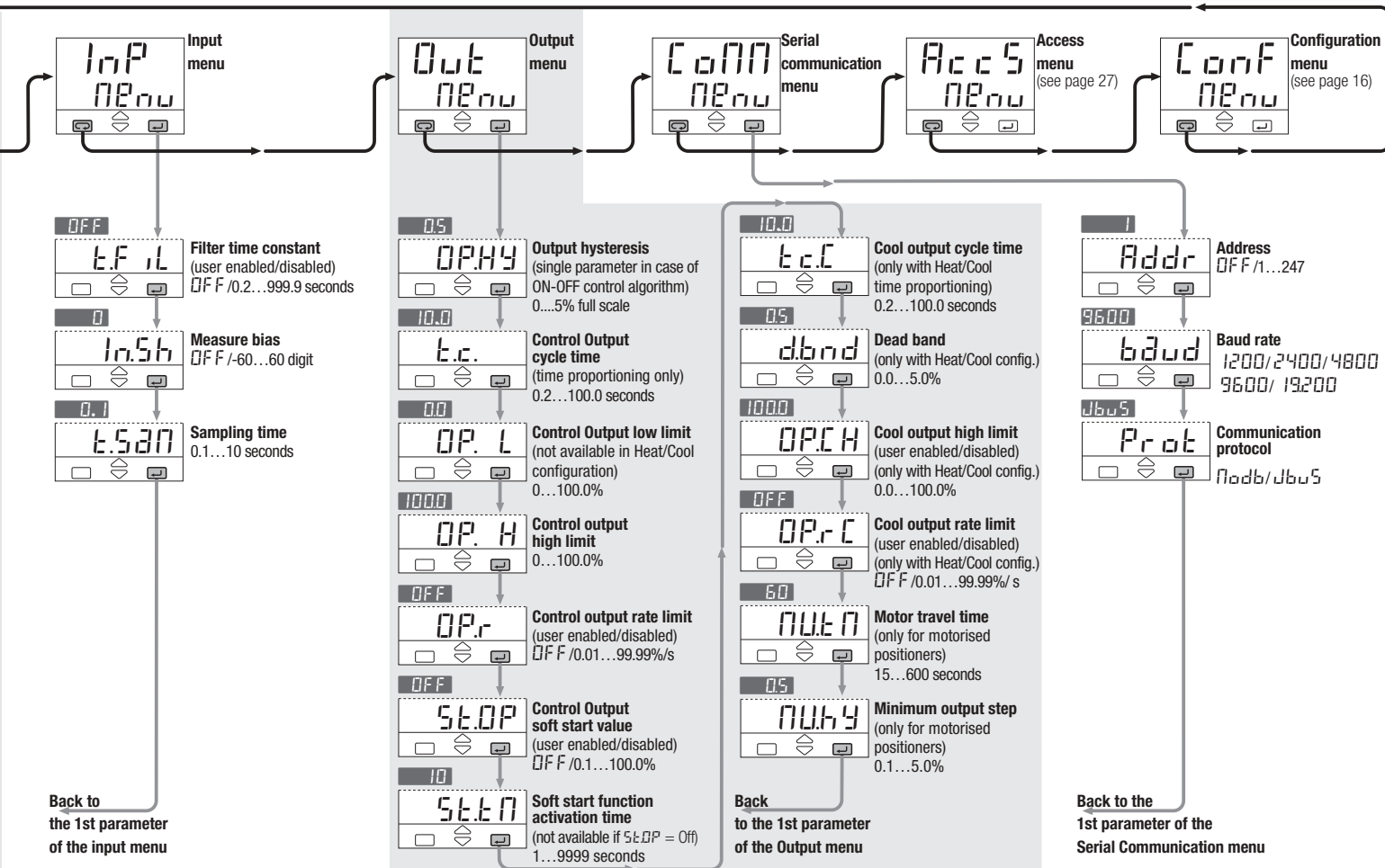

### 4.3.1 PARAMETERS

The controller parameters have been organised in group, according to their functionality area.

#### SETPOINT MENU

**SP. 1** 1st stored Setpoint

**SP. 2** 2nd stored Setpoint

Values of the two Setpoints, that are activated by mean of digital inputs, communication parameters, and keyboard. The Setpoint active is indicated by the **SP1** or **SP2** green led.

**SP. L** Setpoint low limit

**SP. H** Setpoint high limit

High and low limit of the Setpoint SP. The minimum span ( $SP\ 1 - SP\ 2$ ) must be greater than 100 digit.

**SL. u** Setpoint ramp up

**SL. d** Setpoint ramp down

This parameter specifies the maximum rate of change of the Setpoint. Its units are: digit/s, digit/min and digit/hour.

When the parameter is **OFF**, this function is disabled and the new Setpoint value is reached immediately after being entered (through the keyboard, the digital inputs and the serial communication). Otherwise, the

value entered is reached according to the configured rate of change.

**RT 10** Remote Setpoint Ratio

This parameter defines the maximum span of the Remote Setpoint.

**b 125** Remote Setpoint Bias

It defines the low range of the Remote Setpoint, in engineering units.

#### Remote Setpoint Bias and Ratio

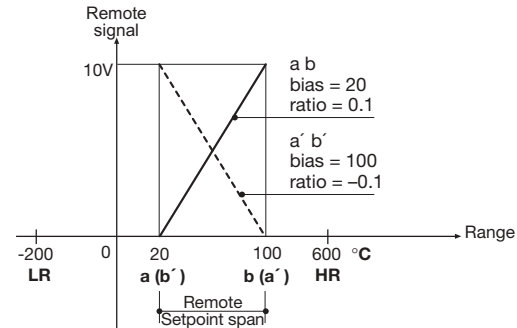

PV = Process variable  
 LR = PV low limit  
 HR = PV high limit  
 SR = Remote Setpoint  
 a (a') = SR starting point  
 b (b') = SR ending point



If SR starting point is **lower** then the ending point, both expressed in engineering units:

$b_{iDS}$  = starting point = a

$$r_{t_{iD}} = \frac{b - a}{HR - LR}$$

Example:

$b_{iDS} = 20$

$r_{t_{iD}} =$

$$\frac{100 - 20}{600 - (-200)} = \frac{80}{800} = 0.1$$

If SR starting point is **higher** then the ending point, both expressed in engineering units

$b_{iDS}$  = starting point = a'

$$r_{t_{iD}} = \frac{b' - a'}{HR - LR}$$

Example:

$b_{iDS} = 100$

$r_{t_{iD}} =$

$$\frac{20 - 100}{600 - (-200)} = \frac{-80}{800} = -0.1$$

### Working Setpoint (SP) as combination of Local Setpoint (SL) and remote signal

Setpoint type  $L_{OCt}$   
(table 3, page 18)

$$SP = SL + (r_{t_{iD}} \cdot REM) + b_{iDS}$$

Setpoint type  $r_{ENt}$   
(table 3, page 18)

$$SP = REM + (r_{t_{iD}} \cdot SL) + b_{iDS}$$

SIGN = Remote signal percentage

SPAN = HR-LR

$$REM = \frac{SIGN \cdot SPAN}{100}$$

Examples:

Local Setpoint (SL) with an external Trim with multiplying coeff. of 1/10:

Setpoint type =  $L_{OCt}$

$r_{t_{iD}} = 0.1$

$b_{iDS} = 0$

Remote Setpoint (SR) with an internal Trim with multiplying coeff. of 1/5:

Setpoint type =  $r_{ENt}$

$r_{t_{iD}} = 0.2$

$b_{iDS} = 0$

Remote Setpoint range equal to the Input range:

Setpoint type =  $L_{OCt}$

$r_{t_{iD}} = 1$

$b_{iDS} = LR$

$5L = 0$

## ALARM MENU

(see page 19)

## P.I.D. MENU

 **Pb**

**Proportional Band**

 **Pb.C**

**Cool Proportional Band**

This parameter specifies the proportional band coefficient that multiplies the error (SP - PV)

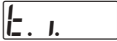
 **E.I**

**Integral Time**

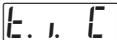
 **E.I.C**

**Cool integral Time**

It is the integral time value, that specifies the time required by the integral term to generate an output equivalent to the proportional term

When  $OFF$  the integral term is not included in the control algorithm.

 **E.d**

**Derivative Time**

 **E.d.C**

**Cool Derivative Time**

It is the derivative term coefficient that specifies the time required by the proportional term P to reach the level of D. When  $OFF$  the derivative term is not included in the control algorithm.

### 4.3.1 PARAMETERS (cont.)

0.C.

#### Overshoot control

(Automatically disabled when the adaptive tune is running)

This parameter specifies the span of action of the overshoot control. Setting lower values ( $1 \rightarrow 0.01$ ) the overshoot generated by a Setpoint change is reduced. The overshoot control doesn't affect the effectiveness of the P.I.D. algorithm.

Setting 1, the overshoot control is disabled.

0.r. 25

#### Manual reset

This term specifies the value of the control output when  $PV = SP$ , in a PD only algorithm (lack of the Integral term).

### TUNING

Two tuning method are provided:

- Initial one shoot **Autotuning**
- Continuous, self learning **Adaptive Tuning**

When the **Autotuning** is started, the controller generates a rapid burst of ON - OFF transition and monitors the response, in order to calculate the optimal P.I.D. terms parameters. Once calculated the terms values are immediately used in the control algorithm. (a minimum error of 5% of span is needed to start the Autotuning)

#### One shot initial autotuning

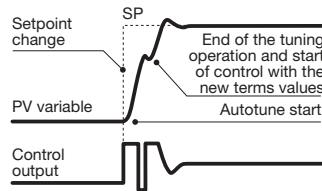

The self-learning **adaptive autotune**, is not intrusive. It doesn't affect the process, at all, during the phase of calculation of the optimal terms parameters.

**It is particularly suitable for controlling process whose control characteristics change with time or are not linear in relation to the Setpoint values.**

It doesn't require any operation by the user. It is simple and works fine: it samples continuously the process response to the various perturbations, determining the frequency and the amplitude of the signals. On the basis of this data and their statistical values, stored in the instrument, it modifies automatically the P.I.D. term parameters.

It is the ideal for all applications where it is required to change continuously the P.I.D. terms parameters, in order to adjust the P.I.D. to the changes of the process dynamic conditions.

#### Continuous adaptive tune

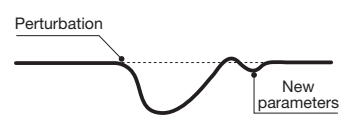

**In case of power off with the Adaptive Tune enabled, the values of the P.I.D. terms parameters are stored, in order to be reused at the next power on.**

**At power on the Adaptive Tune starts automatically.**

### INPUT MENU

E.F. 1L

#### Input filter

Time constant, in seconds, of the RC input filter on the PV input. When this parameter is **OFF** the filter is bypassed.

#### Filter reponse

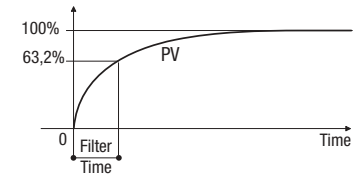

1.56

#### Measure Bias

This value is added to the measured PV input value. Its effect is to shift the whole PV scale of its value ( $\pm 60$  digits).

E.5.20

#### Sampling Time

Sampling time, in seconds, of the instrument. This parameter is normally used when controlling slow process, increasing the sampling time from 0.1 to 10 seconds.

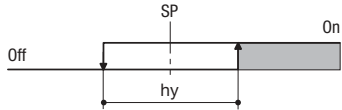
**OUTPUT MENU****OP.HY** Control output hysteresis

Control output hysteresis span, hy, set in % of the full scale.

**OP.C** Control output cycle time**OP.L** Cool output cycle time

It's the cycle time of the time proportioning control output. The P.I.D. control output is provided by the pulse width modulation of the waveform.

**OP.L** Control Output low limit

It specifies the minimum value of the control output signal. It is applied in manual mode, too.

**OP.H** Control output high limit**OP.C.H** Cool output high limit

It specifies the maximum value the control output can be set. It is applied in manual mode, too.

**OP.r** Heat output maximum rate**OP.r.C** Cool output maximum rate

This value, specified in %/seconds, with range from 0.01 to 99.99%/s provides the maximum rate of change of the output. When set to **OFF** this function is disabled.

**SE.OP** Soft start of the control output

It specifies the value at which the control output is set during the start up phase.

**SE.TN** Soft start time

This value specifies the time the start up phase lasts. The start up phase starts at power up of the controller.

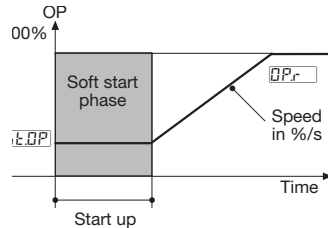
**db.nd** Heat/Cool deadband

This parameter specifies the width of the deadband between the Cool and the Heat channel

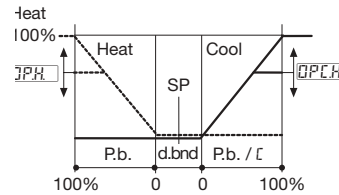
**Heat / Cool algorithm**

..... Heat output  
— Cool output

**TR.TN** Travel time

It provides the time required to the motor positioner to go from the 0% position to 100%

**TR.HY** Minimum step

It specifies the minimum allowed time of activation of the output to a motor positioner that produces a sensible effect. It is related to the deadband of the positioner

**SERIAL COMMUNICATION MENU****Addr** Controller address

The address range is from 1 to 247 and must be unique for each controller on the communication bus to the supervisor. When set to **OFF** the controller is not communicating

**bd.ud** Baud rate

It provides the baud rate in the range from 1200 to 19.200 bit/s.

**Prot** Communication protocol  
*Modb/ibus*

This Slave protocol allows the supervisor to read and write (when it is possible) all the parameters of the controller.

**ACCESS MENU**

(see page 27)

**CONFIGURATION MENU**

(see page 16)

4.4 ACCESS LEVEL - PASSWORD - CALIBRATION

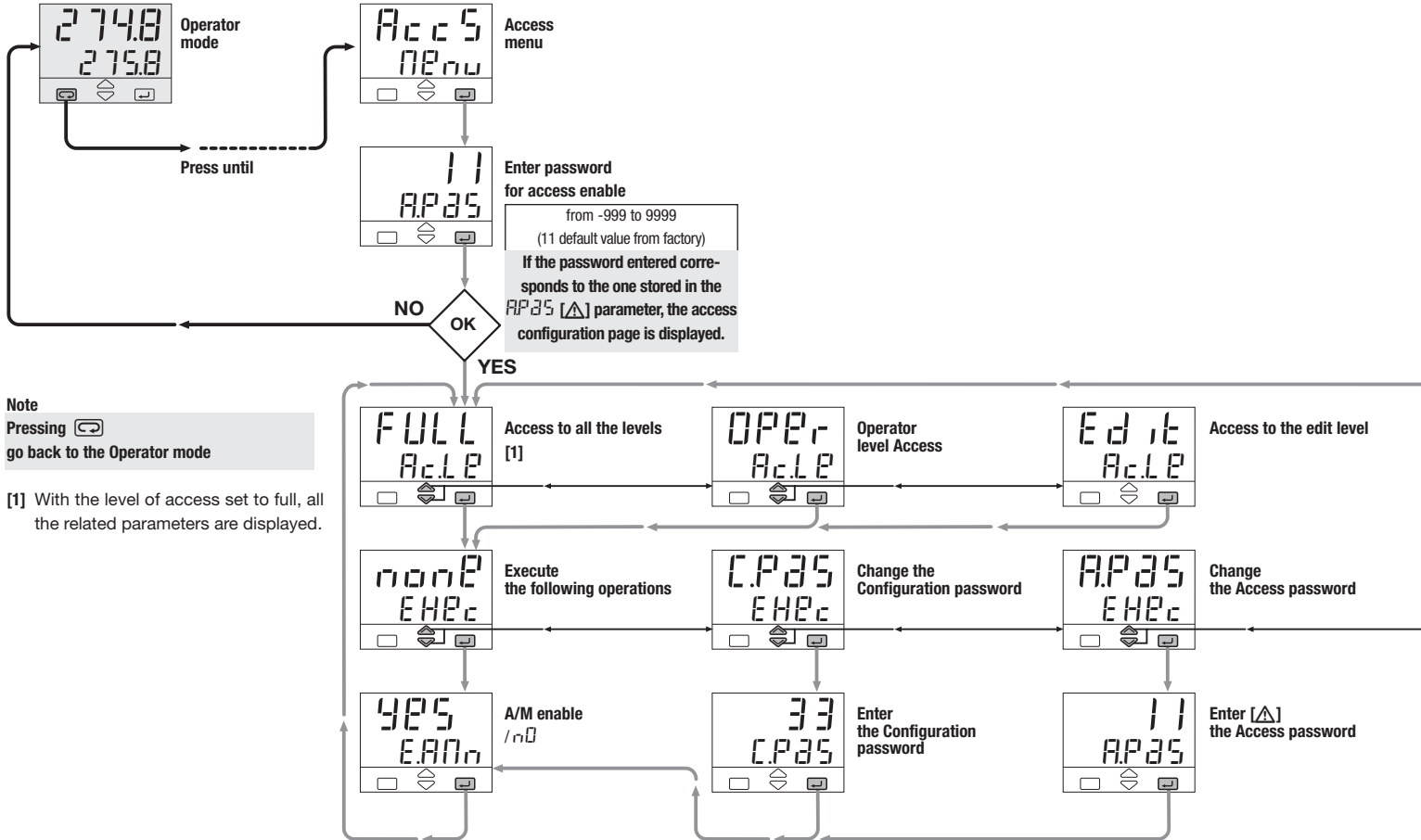





#### 4.4 ACCESS LEVELS PASSWORD CALIBRATION

**With the access level Edit, the user defines which groups and parameters are accessible to the operator**

After selecting and confirming the access level Edit, enter in the parameters menu.

The code of the access level is displayed on the front panel.

Press the  and  keys to select the proper level.

Group of parameters	Code	Access level
	rEd	Visible
	HidE	Not visible
Parameters	Code	Access level
	AlEr	Visible and changeable
	FaSt	Included in "Fast view"
	rEd	Visible only
	HidE	Not visible and not changeable

The parameters in the access level *Fast* are recalled on the front panel through the procedure of fast parameter access illustrated in par. 5.2 pag 29. The maximum number of fast parameters is 10.

At the end of the parameter list of the selected group, the controller quits from the Edit access level.

**Therefore, the Edit level must be selected for each group of parameters**

The access level of groups and parameters, is activated through

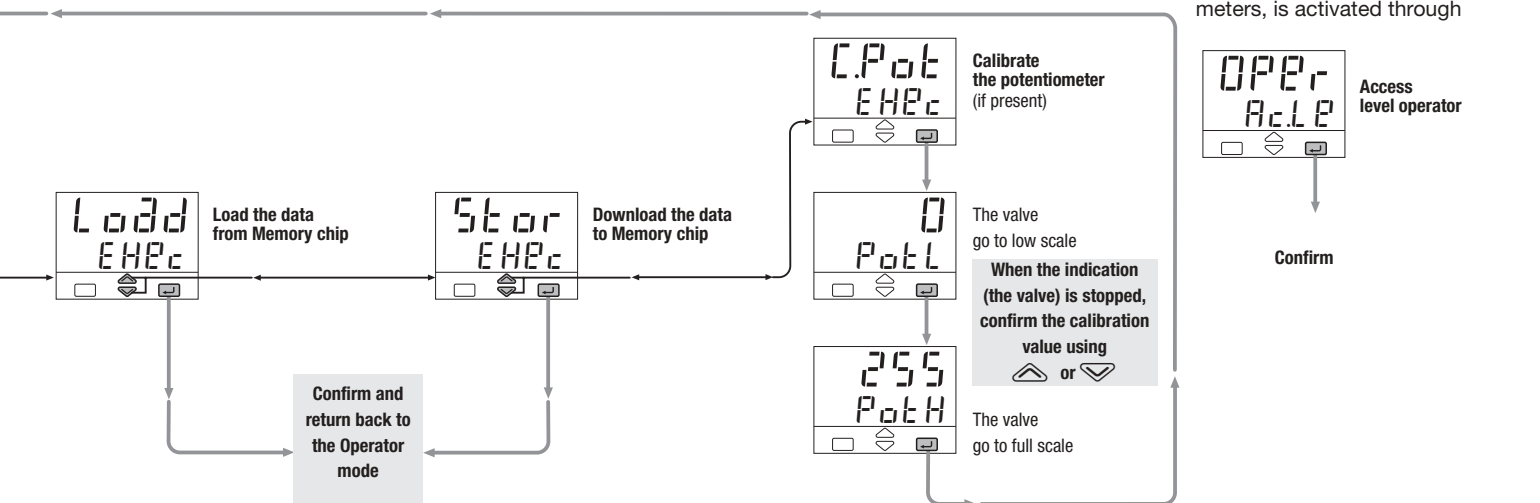

# DISPLAYS

## 5.1 STANDARD DISPLAY

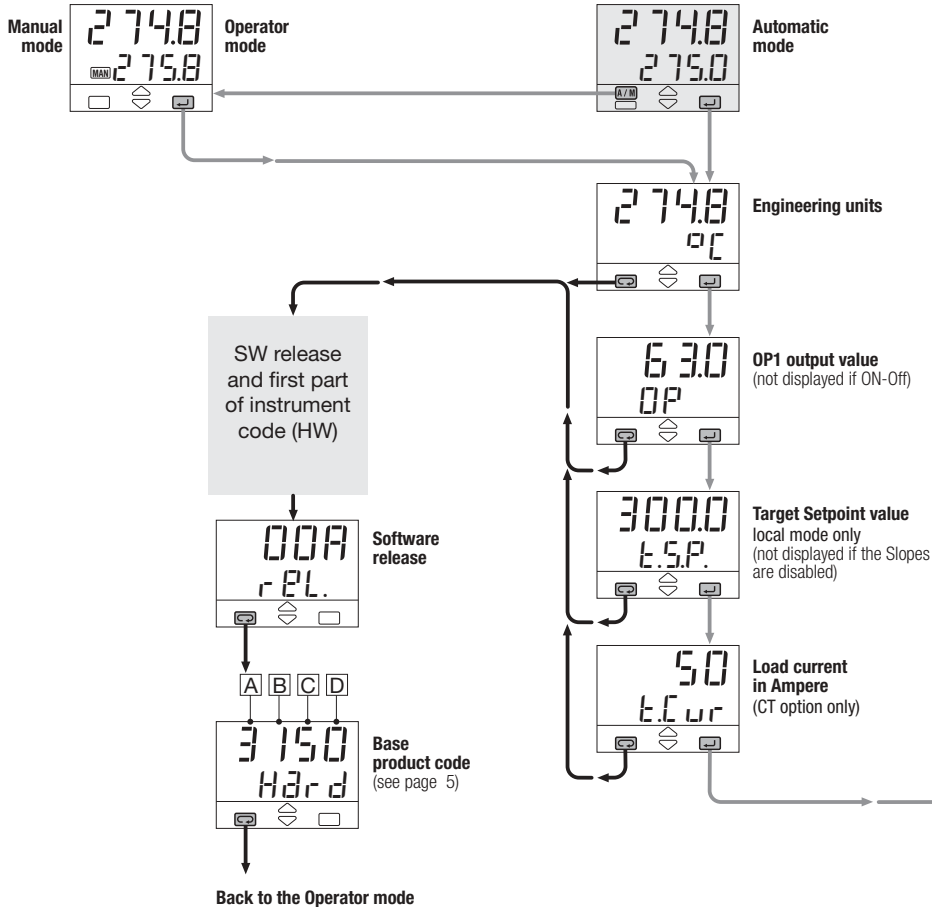

## 5.2 FAST VIEW (fast access to the parameters)

With this procedure, simple and fast, up to 10 parameters, selected through the fast view (see par 4.4 page 28) are displayed and can be modified by the operator without requiring the standard parameter setting procedure. Press in order to modify the parameters. The value is entered by pressing key.

Example of common parameters included in the fast view (fast access)

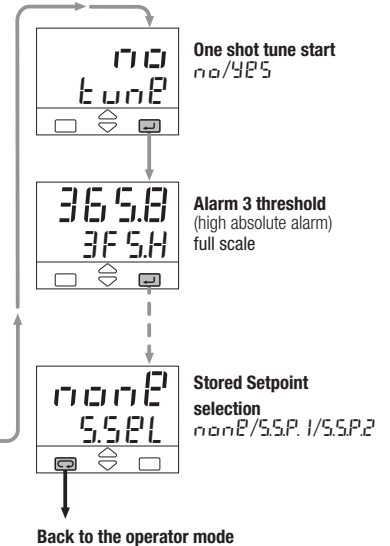

The commands can be entered  
in 3 ways:



### 6.1 KEYBOARD

- Setpoint modification (page 31)
- local/remote selection (page 31)
- stored Setpoint display (page 31)
- manual mode (page 32)
- tuning start (page 32)
- programmer stop (page 38)

### 6.2 DIGITAL INPUTS

see page 33

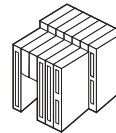

### 6.3 SERIAL COMMUNICATIONS

see the manual on this topic



## 6.1 KEYBOARD COMMANDS

### A. SETPOINT MODIFICATION

The Setpoint is directly modified with the  $\triangle$   $\nabla$  keys.

Once entered, the new value is checked and becomes operating after 2 seconds.

The end of this phase is flagged by flashing momentarily the display with SP.

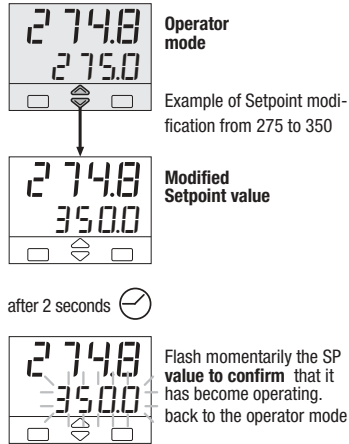

### B. LOCAL/REMOTE

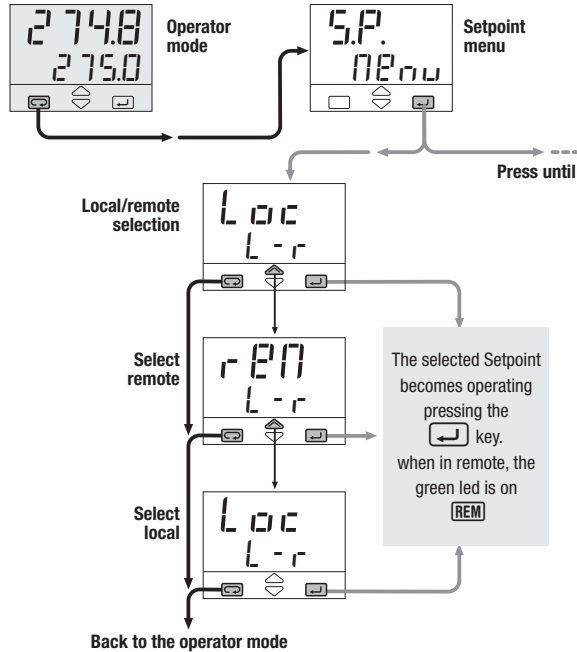

### C. STORED SETPOINTS SELECTION

The Setpoint is directly modified with the  $\triangle$   $\nabla$  keys. Once entered, the new value is checked and becomes operating after 2 seconds. This phase is flagged by flashing momentarily the display with SP.

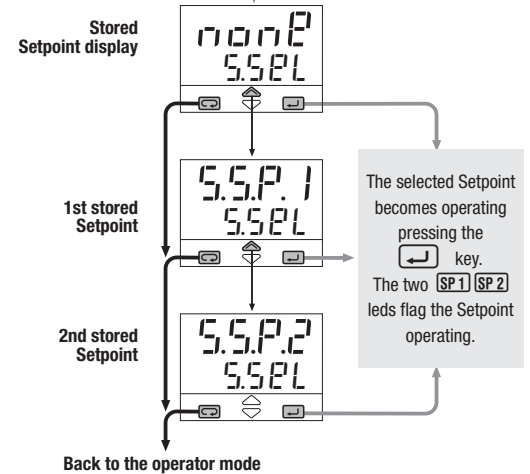

**Note:** When the Setpoint value is changed, the entered value is reached with a maximum rate set by the ramp up  $[SL.u]$  and ramp down,  $[SL.d]$  parameter. This applies to all the models and in all the operating modes.

It is suggested to set  $[SL.u]$  and  $[SL.d]$  to  $OFF$  when the remote Setpoint is operating. The entered Setpoint is defined as target Setpoint. It is displayed in the function menu at the parameter  $L - SP$ .

If the slope parameter is set to zero the Setpoint variation occurs instantaneously.

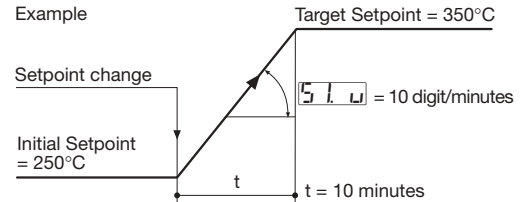



### 6.1.2 AUTO/MANUAL MODE

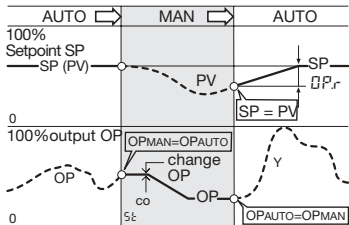
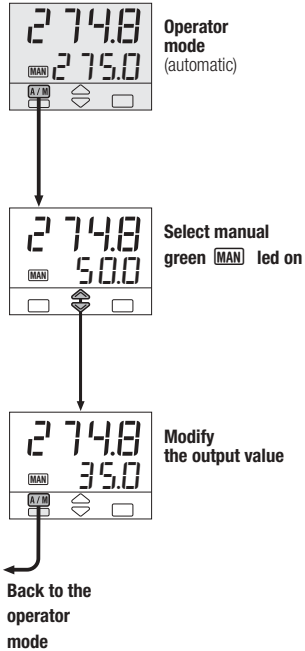

### 6.1.3 TUNING

This controller is provided with 2 different Tuning algorithm

- One shot tune for calculating the optimal P.I.D. terms parameters.
- Continuous tuning (adaptive tune) for a continuous calculation of the P.I.D. terms parameters in order to adapt the control to dynamically changing process or not linear ones.

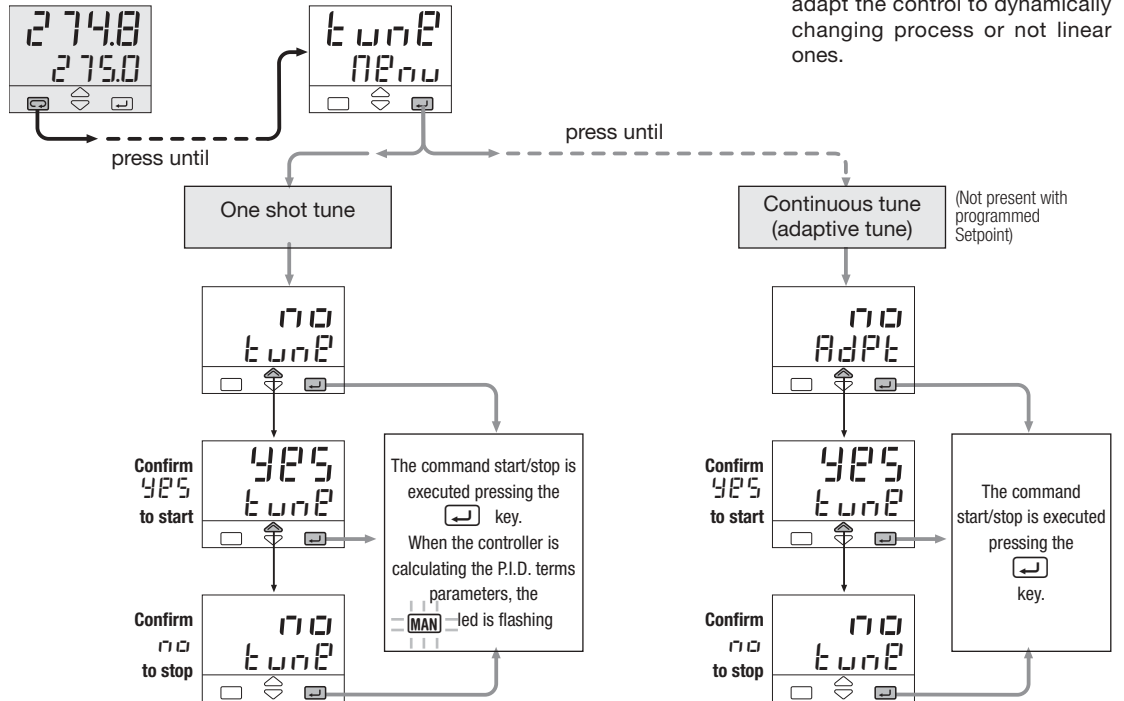

After the execution of the tuning, the calculated values are automatically presented in the P.I.D. menu.











When this function is in progress, the calculated values are visible in the Tuning menu but cannot be modified. (see page 21)

## 6.2 DIGITAL INPUT COMMANDS

A function is assigned, through the configuration procedure to each IL1 and IL2 digital input. (see the parameters setting at tab 8 at pag 17).

The configured function is activated when the digital input (free voltage contact or open collector output) is in the On state. It is deactivated by setting the input to the Off state.

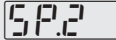
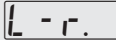
The activation of the function through the digital input has the highest priority than through the keyboard or through the serial communication.

Function		Parameter value	Performed operation		Note
			 Off	 On	
None			—	—	Not used
Set manual mode			Automatic	Manual	
Keypad lock			Unlock	Locked	With the keypad locked the commands from digital inputs and serial communication are still operating
PV measure hold			Normal operation	PV is hold	The value of PV is “frozen” at the time the digital input goes to the close state
Setpoint slopes inhibition			Rate limiting is active	Normal operation	When the input is in the on state, the Setpoint is changed in steps
Standard Setpoint	1st stored Setpoint		Local	1st SP	If more than one digital input is selecting a Setpoint, the last to be activated is the one operating.
	2nd stored Setpoint		Local	2nd SP	
	Remote Setpoint		Local	Remote	
Programmed Setpoint	Start/stop of a program			Hold/Run	The status (RUN/HOLD) changes every time the digital input switches from Off to On.

# PROGRAMMED SETPOINT

## INTRODUCTION

The controller supplied with the Setpoint programmer option (mod. M5-3... 1) offers, in alternative to the adaptive tuning, the functionality to define, store, display and execute a program consisting in the Setpoint profile in time.

## MAIN CHARACTERISTICS

- 1 program, 16 segments/program
- start, stop, hold etc., commands from the keyboard
- time base in seconds, minutes or hours
- continuous or up to 1...9999 time cycling of the program
- 1 OP3 digital output with the state profile defined by the program
- setting of the maximum allowed deviation from the Setpoint

## 7.1 PROGRAM STRUCTURE

The program consists of a sequence of segments.

For each segment, it is specified:

- the Setpoint to reach  $SP_{i-1}$
  - the duration of the segment  $t_{i-1}$
  - the state of the OP3 output
- } always present

The program consists of:

- 1 initial segment named  $I$
- 1 end segment named  $F$
- 1...14 normal segments

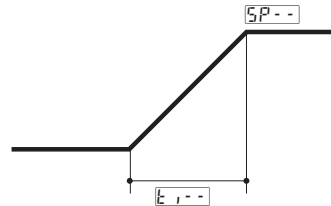

### Initial segment

Its main purpose is to define the value the process variable has to maintain before starting the program.

### End segment

Its main purpose is to define the value the process variable has to maintain at the end of the program and until further changes of Setpoint.

### Normal segments

These segments build up the profile program. There are 3 types of segments:

#### Ramp

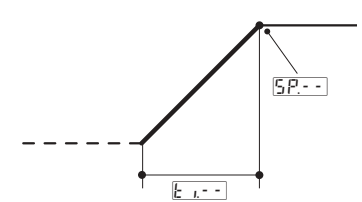

#### Dwell

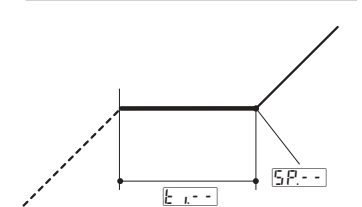

#### Step

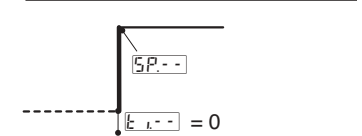

- $SP_{i-1}$  = Target setpoint
- $t_{i-1}$  = Duration
- = Previous segment
- = Current segment
- = Next segment

## EXAMPLE OF SETPOINT PROFILE

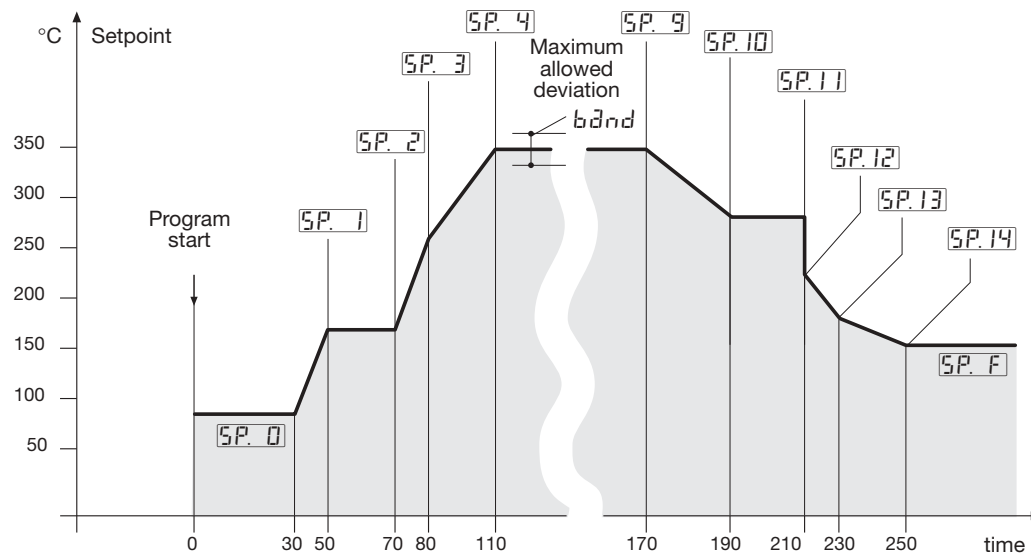

Segment	Initial	1°	2°	3°	4°	5°	9°	10°	11°/12°	13°	14°	End
Time	t0	t1	t2	t3	t4	t5	t9	t10	t11/t12	t13	t14	
OP3 Digital Output	<input type="checkbox"/> I <sub>0</sub>	<input type="checkbox"/> I <sub>0</sub>	<input type="checkbox"/> I <sub>0</sub>	<input type="checkbox"/> I <sub>0</sub>	<input type="checkbox"/> I <sub>0</sub>	<input type="checkbox"/> I <sub>0</sub>	<input type="checkbox"/> I <sub>0</sub>	<input type="checkbox"/> I <sub>0</sub>	<input type="checkbox"/> I <sub>0</sub>	<input type="checkbox"/> I <sub>0</sub>	<input type="checkbox"/> I <sub>0</sub>	<input type="checkbox"/> I <sub>0</sub>
	<input type="checkbox"/> O <sub>n</sub>	<input type="checkbox"/> O <sub>n</sub>	<input type="checkbox"/> O <sub>n</sub>	<input type="checkbox"/> O <sub>n</sub>	<input type="checkbox"/> O <sub>n</sub>	<input type="checkbox"/> O <sub>n</sub>	<input type="checkbox"/> O <sub>n</sub>	<input type="checkbox"/> O <sub>n</sub>	<input type="checkbox"/> O <sub>n</sub>	<input type="checkbox"/> O <sub>n</sub>	<input type="checkbox"/> O <sub>n</sub>	<input type="checkbox"/> O <sub>n</sub>

The OP3 digital output state, during the segments, is defined in the program

I<sub>0</sub> contact close (On)

O<sub>n</sub> contact open (Off)

## 7.2 SETPOINT PROGRAMMER OPERATION

### 7.2.1 MAXIMUM ALLOWED DEVIATION ( *bnd* )

If the PV controlled input value exceeds the band, centred around the SP, the segment time is extended of the same time the PV input stays out of the band. The band width is defined in a parameter of the program segment.

The actual segment period is calculated as  $t_{ramp} + T_i$

#### A. Ramp

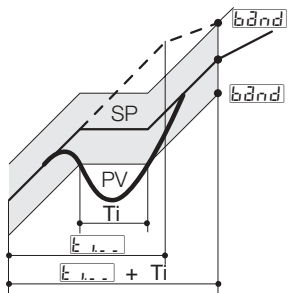

#### B. Dwell

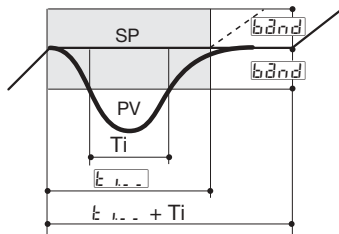

### 7.2.2 RE-START OF A PROGRAM AFTER A POWER FAILURE

The parameter *Fail* specifies the behaviour of the programmer at power up (see pag.37). Selected between the following 3 choices:

*Cont* Continue

*res* Reset

*ramp* Ramp

If *Cont* is selected, the execution of the program starts from the point reached at the power failure time.

All the parameters, like Setpoint and the remaining time are restored at the values they had at power off.

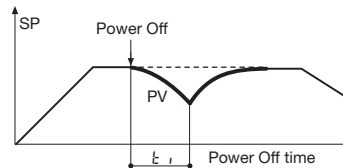

If *res* is selected, after power on the program ends and goes back to local mode.

If *ramp* is selected, the execution of the program starts from the point reached at the power failure time.

In this case, the programs continue with PV reaching SV with a ramp, whose slope corresponds to the one of the segment running at the power off.

The drawing below illustrates the situation.

#### Power off during a dwell

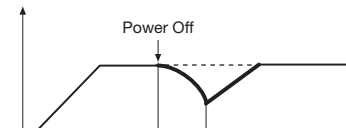

#### Power off during a ramp

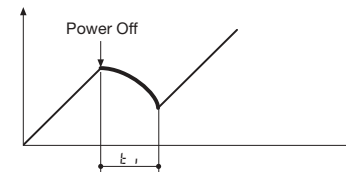

### 7.3 CREATION AND MODIFICATION OF A PROG.

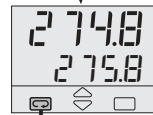

Operator mode



Program menu  
(if present)

### PARAMETER MENU

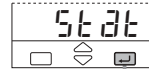

Program status  
r<sub>PS</sub> = reset  
H<sub>oLd</sub> = hold  
r<sub>un</sub> = start



Restart after a power off  
C<sub>ont</sub> = continue  
r<sub>PS</sub> = reset  
r<sub>AMP</sub> = continue with the slope



Time units  
P<sub>Sec</sub> = seconds  
P<sub>Min</sub> = minutes  
P<sub>hr</sub> = hours

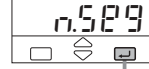

No. of segments  
1...14 max.

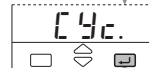

No. of program cycles  
OFF / 1...9999

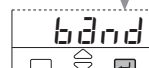

Allowed deviation  
OFF / 0...span/20

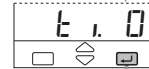

Segment 0 time  
0.1...999.9 Unit

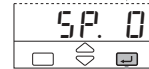

Segment 0 Setpoint  
whole range

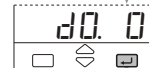

Segment 0 Digital output [1]  
C<sub>L</sub> = closed  
O<sub>P</sub> = open  
O<sub>FF</sub> = inhibited

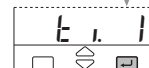

Segment 1 time  
0.1...999.9 Unit

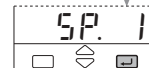

Segment 1 Setpoint  
Intra scale

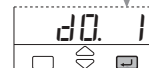

Segment 1 Digital output [1]

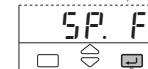

End segment Setpoint  
whole range

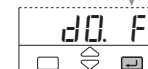

End segment digital output [1]  
C<sub>L</sub> = closed  
O<sub>P</sub> = open  
O<sub>FF</sub> = inhibited

Back to the 1st parameter

Continue for all the 14 normal segments

[1] One digital output is provided which can be controlled by the program. This output is OP3. If this functionality is not required, it can be inhibited by setting OFF the parameter dO...

### 7.4 START/STOP OF A PROGRAM

The various commands, supported by the controller, are different for each of the following operating phases:

- A] when in Local Setpoint mode
- B] during the execution of a program
- C] when the program is in hold

Commands supported by the controllers

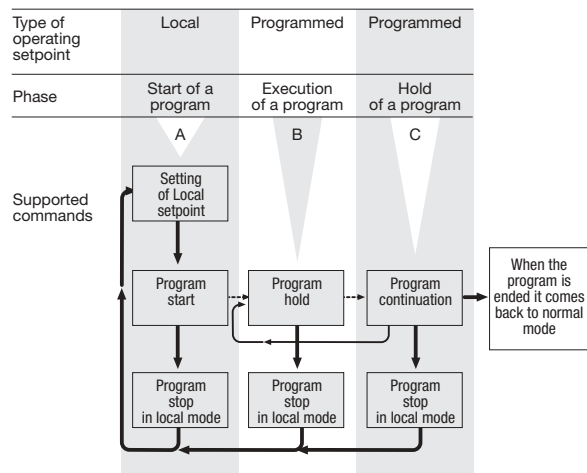

The different phase are displayed in a chained way, just for easing the understanding of the functionality.

Two different mode for starting and stopping a program are provided:

- direct mode with the key
- through the parameter menu

### DIRECT MODE WITH

### THROUGH THE PARAMETER MENU

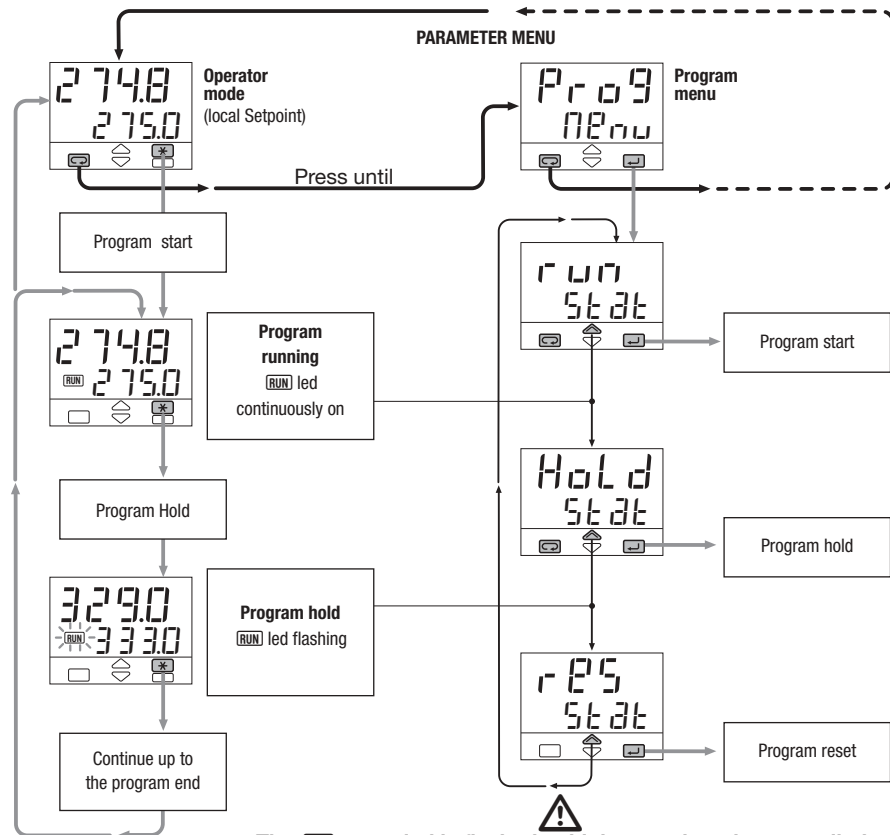

**The green led is flashed at high rate when the controlled variable is out of the allowed deviation band**  
**The current time of a segment is hold up to the time the variable re-enter in the band.**

## 8 TECHNICAL SPECIFICATIONS

Features at 25 °C env. temp.	Description			
<b>Total configurability</b>	The choices are: input type, operating mode, type of control, safety strategies, alarm strategies			
<b>Operating modes</b>	1 loop with single/double output			
	1 loop as the latter with the addition of the Setpoint programmer			
<b>Control mode</b>	Algorithm	P.I.D. with overshoot control or On-off		
		P.I.D. with velocity algorithm, for controlling motorised positioners		
	Proportional band (P)	0.1...999.9%		
	Integral time (I)	1...9999 s	(user enabled/disabled)	P.I.D. control
	Derivative time (D)	0.1...999.9 s		
	Error band	0.1...10.0 digit		
	Manual reset	1...100% output	(user enabled/disabled)	Time proportioning control
	Cycle time	0.2...100.0 s		Discontinuous control
	Hysteresis	0.1...5.0%		ON-Off control
	Dead band	0.0...5.0%		
	Cool proportional band	0.1...999.9%		
	Cool Integral time	1...9999 s	(user enabled/disabled)	Heat/Cool control
	Cool Derivative time	0.1...999.9 s		
	Cool cycle time	0.2...100.0 s		
	Motor travel time	15...600 s		
Motor minimum step	0.1...5.0%		Motorised positioner	
Feedback potentiometer	100Ω...10kΩ			
<b>PV input</b> (see table 1 page 18 for the signal ranges)	Common characteristics	A/D converter with resolution of 160000 points Update measurement time: 50 ms Sampling time (max. update time of the output): 0.1...10.0 s configurable Input bias: - 60...+60 digit Input filter with enable/disable 0.1...999.9 s		
	Accuracy	0.25% ±1 digits for temperature sensors 0.1% ±1digits (for mV and mA)	Between 100...240Vac the error is minimal	



Features at 25 °C env. temp.	Description			
<b>PV input</b>	Resistance thermometer (for $\Delta T$ : R1+ R2 must be $<320\Omega$ )	Pt100 $\Omega$ a 0°C (IEC 751) °C/°F selectable	2 or 3 wires or 2 Pt100 for $\Delta T$	Max. wire res.: 20 $\Omega$ (3 wires) Input drift: 0.1°C/10°C Env. temperature <0.1°C/10 $\Omega$ Wire Resistance
	Thermocouple	L, J, T, K, R, S (IEC 548) °C/°F selectable	Internal cold junction compensation	Max. wire res.: 150 $\Omega$ Input drift: <2 $\mu$ V/°C Env. temperature <5 $\mu$ V/10 $\Omega$ Wire Resistance
	DC input (current)	0/4...20mA Rj = 30 $\Omega$	Engineering units Configurable decimal point position with or without $\sqrt{\quad}$ Initial scale.: -999...9999 Full scale.: -999...9999 (minimum range of 100 digits)	Input drift: <0.1%/20°C Env. Temp. <5 $\mu$ V/10 $\Omega$ Wire Res.
	DC input (voltage)	0...50 mV Rj = 10M $\Omega$ 1...5/0...5/0...10V Rj = 10k $\Omega$		
<b>Auxiliary inputs</b> (options)	Remote Setpoint Not isolated accuracy 0.1%	Current 0/4...20mA Rj = 30 $\Omega$	Bias in engineering units and $\pm$ range	
		Voltage 1...5/ 0...5/ 0...10V Rj = 300k $\Omega$	Ratio from -9.99...+99.99 Local + Remote Setpoint	
	CT current transformer	max. span 50 or 100 mA hardware selectable	Display from 10 to 200 A resolution of 1A with alarm threshold (Heater break alarm)	
	Potentiometer	100 $\Omega$ ...10k $\Omega$ supply 300mV	Position feedback measurement	
<b>Digital inputs</b>	2 logic	The closure of the external contact produces any of the following actions:	Auto/Man mode change, Local/Remote Setpoint mode change, Stored Setpoints activation, keypad lock, measure hold and slopes inhibit.	
			Start, stop, hold of a program (only with Setpoint programmer)	
<b>Control output</b> (cont.)	Single or double channel, direct or reverse action			
	Minimum limit	0...100.0% (OP1 heat)		
	Maximum limit	0...100.0% (OP1 heat), -100.0...0% (OP2 cool)		

Features at 25 °C env. temp.	Description				
<b>Control output</b>	Maximum slope	0.01...99.99%/s up and down			
	Safety value	-100...100% . (user enabled/disabled)			
	Time proportioning	Relays	NO 2A/250Vac resistive loads		
		Triac	1A/250Vac resistive loads		
		SSR drive	0...22Vdc, 20mA max. (for static switches)		
	Analogue	Current	0/4...20mA max. 750Ω/10V max.	Galvanic isolation 500Vac/1min Resol.: 12 bit (0.025%) Accur. 0.1%. Short circuit protection	
		Voltage	0...1/5/10V 500Ω / 20mA max.		
Motor positioner (3 states) Increase - Stop - Decrease	Double action 2 poles NO, 2A/250Vac resistive load				
<b>Alarms</b>	SPST NO, 2A/250Vac resistive load Hysteresis 0.1...5.0% symmetrical				
	Actions	Active high	Action type	Deviation threshold	± range
		Active low		Band width	0...range
				Absolute threshold	Whole scale
	Special functions	Heater Break detection			
		Loop Break Alarm			
		Activation inhibit (blocking)			
Acknowledge (latching)					
Related to the program (optional) (OP3)					
<b>OP4 analogue output (optional)</b>	Galvanic isolation: 500 Vac/1min. Resolution: 12 bit (0.025%) Accuracy: 0.1% . Short circuit protected		Current: 0/4...20mA 750Ω/10V max.	Retransmission of PV or SP	
Voltage: 1...5/0...5/0...10V 500Ω/20mA max.					
<b>Setpoint</b>	Ramp up and down, with slope in digit/s, digit/minute or digit/hour between 0.0...10.0% of the range High and low limits		Local plus 2 stored Setpoints		
Only Remote					
Local and Remote					
Local with trim					
Remote with trim					
Time programmable (optional)					

## 8 - Technical Specifications











Features at 25 °C env. temp.	Description	
<b>Programmable Setpoint</b> (optional)	1 program, 16 segments (1 initial and 1 end) From 1 to 9999 cycles or continuous cycling (FFF) Time values in seconds, minutes and hours Start, stop, hold, etc. activated from the keyboard, digital input and serial communications.	
<b>Tuning</b>	One shot Tune- step response method for calculating the P.I.D. terms parameters	
	Adaptive Tune self-learning, not intrusive, analysis of the process response to perturbations and continuously calculation of the P.I.D. parameters (not available with the Setpoint Programmer option)	
<b>Auto/Manual station</b>	Integrated in the controller, bumpless Operated from keyboard, digital input and serial communication.	
<b>Serial com.</b> (optional)	RS485 isolated, Modbus-Jbus, 1200, 2400, 4800, 9600, 19200 bit/s, 2 wires	
<b>Auxil. supply</b>	18Vdc $\pm$ 20%, 30mA max. for transmitters (2, 3, 4 wires)	
<b>Operational safety</b>	Measure input	Detection of out of range, short circuit or sensor break with automatic activation of the safety strategies and alerts on display
	Control output	Safety value: -100...+100% (user enabled/disabled)
	Parameters	Parameters and configuration data are stored in a non volatile memory for an unlimited time. They are organised in functionally homogeneous groups, like: visible and changeable, visible and not changeable, not visible.
	Access protection	Password to access the configuration data and the parameter protection menu
<b>General characteristics</b>	Supply	100...240Vac (-15...+10%) 50/60Hz or 24Vac (-25...+12%) 50/60Hz and 24Vdc (-15...+25%) power consumption 3W max.
	Electric safety	Compliance to EN61010, installation class 2 (2500V) pollution class 2
	Electromagnetic compatibility	Compliance to the CE standards for industrial system and equipment
	UL and cUL approvals	File E176452
	Protection EN650529	IP20 termination unit, IP65 front panel
	Dimensions	$\frac{1}{16}$ DIN - 48 x 48, depth 150 mm, weight 230 g approx.













 **WARRANTY**











We warrant that the products will be free from defects in material and workmanship for 18 months from the date of delivery.

The warranty above shall not apply for any failure caused by the use of the product not in line with the instructions reported on this manual.

## ICONS TABLE

<b>Main universal input</b>	
	Thermocouple
	RTD (Pt100)
	Delta Temp (2x RTD)
	mA and mV
	Custom
	Frequency
<b>Auxiliary input</b>	
	Current transformer
	mA Remote setpoint
	Volt Remote setpoint
	Feedback potentiometer

<b>Digital input</b>	
	Isolated contact
	NPN open collector
	TTL open collector
<b>Setpoint</b>	
	Local
	Stand-by
	Keypad lock
	Outputs lock
	Start-up function
	Timer function
	Memorized
	Remote
	Setpoint programmer

<b>Digital input connected functions</b>	
	Auto/Manual
	Run, Hold, Reset and program selection
	PV hold
	Setpoint slopes inhibition
<b>Output</b>	
	SPST Relay
	Triac
	SPDT Relay
	mA
	mA mV
	Logic



