

# DATASHEET

**STOBER**  
FAS4020

**OTHER SYMBOLS:**

**RGB ELEKTRONIKA AGACIAK CIACIEK**  
**SPÓŁKA JAWNA**

Jana Długosza 2-6 Street  
51-162 Wrocław  
Poland

✉ [biuro@rgbelektronika.pl](mailto:biuro@rgbelektronika.pl)

☎ +48 71 325 15 05



[www.rgbelektronika.pl](http://www.rgbelektronika.pl)



[www.rgbautomatyka.pl](http://www.rgbautomatyka.pl)

# YOUR PARTNER IN MAINTENANCE

Repair **this product** with RGB ELEKTRONIKA

[ORDER A DIAGNOSIS »](#)



At our premises in Wrocław, we have a fully equipped servicing facility. Here we perform all the repair works and test each later sold unit. Our trained employees, equipped with a wide variety of tools and having several testing stands at their disposal, are a guarantee of the highest quality service.

Buy **this product** at RGB AUTOMATYKA

[BUY »](#)

# FREQUENCY INVERTER POSIDRIVE® FAS 4000

Installation and Commissioning Instructions

It is essential to read and comply with these instructions prior to installation and commissioning.

MANAGEMENTSYSTEM



certified by DQS according to  
DIN EN ISO 9001, DIN EN ISO 14001  
Reg-No. 000780 UM/QM

**VECTOR CONTROL VC**

**SENSORLESS VC**

**V/F-CONTROL**



**SV. 4.5**

**GB 02/2004**



**Table of Contents**

|   |          |  |           |
|---|----------|--|-----------|
| <b>1. Notes on safety</b>                       | <b>1</b> | <b>10. Positioning Control</b>                     | <b>12</b> |
| <b>2. Technical specifications</b>              | <b>2</b> | <b>11. Parameter Description</b>                   | <b>13</b> |
| <b>3. Physical installation</b>                 | <b>3</b> | <b>12. Option board 24 V-LC</b>                    | <b>31</b> |
| 3.1 Installation site                           | 3        | <b>13. Result Table</b>                            | <b>32</b> |
| <b>4. Electrical installation</b>               | <b>3</b> | <b>14. Operating States</b>                        | <b>33</b> |
| 4.1 EMC-compatible installation                 | 4        | <b>15. Faults/Events</b>                           | <b>34</b> |
| 4.2 FI circuit breaker                          | 4        | <b>16. Block Circuit Diagram - Ref. Val. Proc.</b> | <b>36</b> |
| <b>5. Connection assignment-control portion</b> | <b>5</b> | <b>17. Accessories</b>                             | <b>37</b> |
| <b>6. Differences from FDS 4000</b>             | <b>6</b> | 17.1 Accessories overview                          | 37        |
| <b>7. Operator control</b>                      | <b>6</b> | 17.2 Braking resistor                              | 39        |
| 7.1 Operational states                          | 6        | 17.2.1 Allocation of braking resistor to FAS 4000  | 39        |
| 7.2 Paramodule                                  | 6        | 17.2.2 Braking resistor FZM / FZZM (dimensions)    | 39        |
| 7.3 Controlbox                                  | 6        | 17.2.3 Braking resistor VHPR (dimensions)          | 40        |
| 7.3.1 Operation indication                      | 7        | 17.3 Output reactor                                | 40        |
| 7.3.2 Parameterization                          | 7        | 17.3.1 Allocation of output derating to FAS 4000   | 40        |
| 7.3.3 Password                                  | 8        | 17.3.2 Output reactor RU (dimensions)              | 40        |
| <b>8. Commissioning (with Controlbox)</b>       | <b>8</b> |  |           |
| 8.1 Primary parameters                          | 8        |  |           |
| 8.2 Motor type                                  | 8        |  |           |
| 8.3 Reference value via Controlbox              | 8        |  |           |
| 8.4 Analog/frequency reference value            | 8        |  |           |
| 8.5 Fixed ref. values (digital ref. values)     | 9        |  |           |
| 8.6 Brake control                               | 9        |  |           |
| 8.7 Parameter transmission                      | 9        |  |           |
| <b>9. Special Functions</b>                     | <b>9</b> |  |           |
| 9.1 Binary inputs BE1 to BE5                    | 10       |  |           |
| 9.2 Torque limits                               | 10       |  |           |
| 9.3 Operating range                             | 10       |  |           |
| 9.4 Parameter record switchover                 | 10       |  |           |
| 9.5 Motor potentiometer                         | 10       |  |           |
| 9.6 Speed feedback                              | 11       |  |           |
| 9.7 Acknowledgment of malfunctions              | 12       |  |           |
| 9.8 Motor startup                               | 12       |  |           |
| 9.9 Control via PC                              | 12       |  |           |

1. Notes on Safety

**1 NOTES ON SAFETY**



To prevent avoidable problems from occurring during commissioning and/or operation, it is essential to read and comply with this entire instruction manual before starting installation and commissioning.

Based on DIN EN 50178 (once VDE 0160), FAS-series frequency inverters are defined as electronic power equipment (BLE) for the control of power flow in high-voltage systems. They are designed exclusively to power three-phase-current, asynchronous machines. Handling, installation, operation and maintenance must be performed in accordance with valid and/or legal regulations, applicable standards and this technical documentation.

The frequency inverter are products of the restricted sales class (in accordance with IEC 61800-3). Use of this products in residential areas may cause high-frequency interference in which case the user may be ordered to take suitable measures.

**The user must ensure strict adherence to these standards.**

The safety notes and specifications stated in additional sections (items) must be adhered to by the user.

**Caution! High touch voltage! Danger of electric shock! Danger of death!**



Never under any circumstances may the housing be left open or connections disconnected when the power is on. Disconnect the power plug of the frequency inverter and wait at least 5 minutes after the power voltage has been switched off before opening the frequency inverter to install or remove option boards. Correct configuration and installation of the inverter drive are prerequisites to correct operation of the frequency inverter. Only appropriately qualified personnel may transport, install, commission and operate this device.

**Pay particular attention to the following:**

- Permissible protection class: Protective ground; operation only permitted when protective conductor is correctly connected. The devices may not be operated directly on IT networks.
- Installation work may only be performed in a voltage-free state. When work has to be done on the drive, inhibit the enable and disconnect the complete drive from the power network. Adhere to the 5 safety regulations.
- Discharge time of the DC link capacitors > 5 minutes
- Do not penetrate the interior of the device with any kind of object.
- When performing installation or other work in the switching cabinet, protect the device against falling objects (e.g., pieces of wire, flexible leads, metal parts and so on). Conductive parts may cause short circuiting or device failure on the frequency inverter.
- Before commissioning, remove all extra coverings to prevent the device from overheating.

The frequency inverter must be installed in a switching cabinet which does not exceed the maximum ambient temperature (see technical data). Only copper wiring may be used. For wire cross sections, see table 310-16 of standard NEC at 60° C or 75° C.

**STÖBER ANTRIEBSTECHNIK accepts no liability for damages caused by non-adherence to the instructions or applicable regulations.**

The motor must have an integral temperature monitoring device or external motor overload protection must be used.

Only suitable for use on power networks which cannot supply more than a symmetric, nominal short-circuit current of 5000 A at 240 V ac / 480 V ac.

**Notes:**

**Subject to technical changes for improvement of the devices without prior notice. This documentation is solely a product description. It is not a promise of features in the sense of warranty rights.**

2. Technical Specifications

| Model   | Model 1 / BG I  |           |  |           |           |           | Model 2 / BG II   |           |
|---|---|-----------|--|-----------|-----------|-----------|---|-----------|
| Type of device  | FAS 4008  | FAS 4016* | FAS 4009   | FAS 4014* | FAS 4020* | FAS 4028* | FAS 4038*   | FAS 4050* |
| Connection voltage  | (L1-N) 1 x 230 V<br>+20%/-55% <sup>1)</sup> / 50/60 Hz  |           | (L1-L3) 3 x 400 V<br>+28%/-55% <sup>1)</sup> / 50/60 Hz    |           |           |           |   |           |
| Recommended motor power <sup>2)</sup>                         | 0.37 kW   | 0.75 kW   | 0.37 kW  | 0.75 kW   | 1.1 kW    | 1.5 kW    | 2.2 kW  | 3.0 kW    |
| Nominal current I <sub>N</sub> <sup>3)</sup>                  | 3 x 2.1 A   | 3 x 4.0 A | 3 x 1.3 A  | 3 x 2.1 A | 3 x 2.9 A | 3 x 4.0 A | 3 x 5.5 A   | 3 x 7.0 A |
| Power fuses <sup>4)</sup>                                     | 1 x 6 AT  | 1 x 10 AT | 3 x 6 AT   |           |           | 3 x 10 AT |   |           |
| Output voltage  | 3 x 0 V up to connection voltage  |           |  |           |           |           |   |           |
| Output frequency  | 0 - 200 Hz (vector control: 0 - 100 Hz;<br>spindles: 0 - 400 Hz at <b>B20=0V/f-control</b> and <b>B24=8 kHz</b> )/resolution of 0.01 Hz                                     |           |  |           |           |           |   |           |
| I <sub>max</sub>  | 200% I <sub>N</sub> / 2 sec, 150% I <sub>N</sub> / 30 sec   |           |  |           |           |           |   |           |
| Clock pulse frequency   | 4 kHz (adjustable up to 16 kHz with current derating of 46% I <sub>N</sub> at 16 kHz, 75% I <sub>N</sub> at 8 kHz)  |           |  |           |           |           |   |           |
| Braking resistance (accessories)                              | ≥ 100 Ω;<br>max. of 320 W const.,<br>max. of 1.8 kW for 1 sec   |           | ≥ 200 Ω; max. of 640 W const.,<br>max. of 3.2 kW for 1 sec |           |           |           | ≥ 100 Ω;<br>max. of 1.28 kW const.,<br>max. of 6.4 kW for 1 sec |           |
| RFI suppression <sup>5)</sup>                                 | Integrated network filter for compliance with RFI suppression in acc. w. EN 55011, class B / residential zoning (motor cable up to 5 m); class A / industrial zoning (25 m) |           |  |           |           |           |   |           |
| Interference immunity   | EN 61000 -4 -2, -3, -4, -5 / industrial zoning  |           |  |           |           |           |   |           |
| Permissible length of motor cable                             | 25 m, proportionately shorter when several motors are used.<br>Longer lengths or parallel installation to encoder cable with output reactor.                                |           |  |           |           |           |   |           |
| Ambient temperature   | 0° to 45° C for nominal data  |           |  |           |           |           | 0 to +40 °C<br>f. nom. data.                                    |           |
|   | Up to 55° C with power reduction of 2.5% /°   |           |  |           |           |           |   |           |
| Storage temperature   | -20 °C to +70 °C, max. change 20 K / h  |           |  |           |           |           |   |           |
| Humidity during operation                                     | Relative humidity of 85%, no condensation   |           |  |           |           |           |   |           |
| Power loss  | 30 W  | 60 W      | 22 W   | 33 W      | 42 W      | 60 W      | 80 W  | 100 W     |
| Protection rating   | IP 20   |           |  |           |           |           |   |           |
| Dimensions W x H x D (in mm)                                  | 60 x 300 x 160  |           |  |           |           |           | 80 x 300 x 160  |           |
| Core cross section (in mm <sup>2</sup> )<br>Motor cable/power | Max. of 2.5   |           |  |           |           |           |   |           |
| Weight (in kg)<br>- Without packing<br>- With packing         | 2.1<br>3.1  |           |  |           |           |           | 2.6<br>3.6  |           |

\* Externally ventilated (integrated fan)

<sup>1)</sup> Power networks ≠ 400 V: Low voltage limit **A35** and **A36** may have to be adjusted.

<sup>2)</sup> For nominal connection voltage, clock pulse frequency 4 kHz, 4-pin asynchronous machine, motor cable shielded 25 m

<sup>3)</sup> With S1, clock pulse frequency 4 kHz

<sup>4)</sup> Line circuit breaker - tripping characteristic D in accordance with EN 60898  
For UL conformity, use class RK1 fuses. 1~: Class RK1 / 250 V  
3~: Class RK1 / 600 V

<sup>5)</sup> Clock pulse frequency 4 kHz, motor cable shielded and applied on both sides

3. Physical Installation  
4. Elektrische Installation

**3 PHYSICAL INSTALLATION**

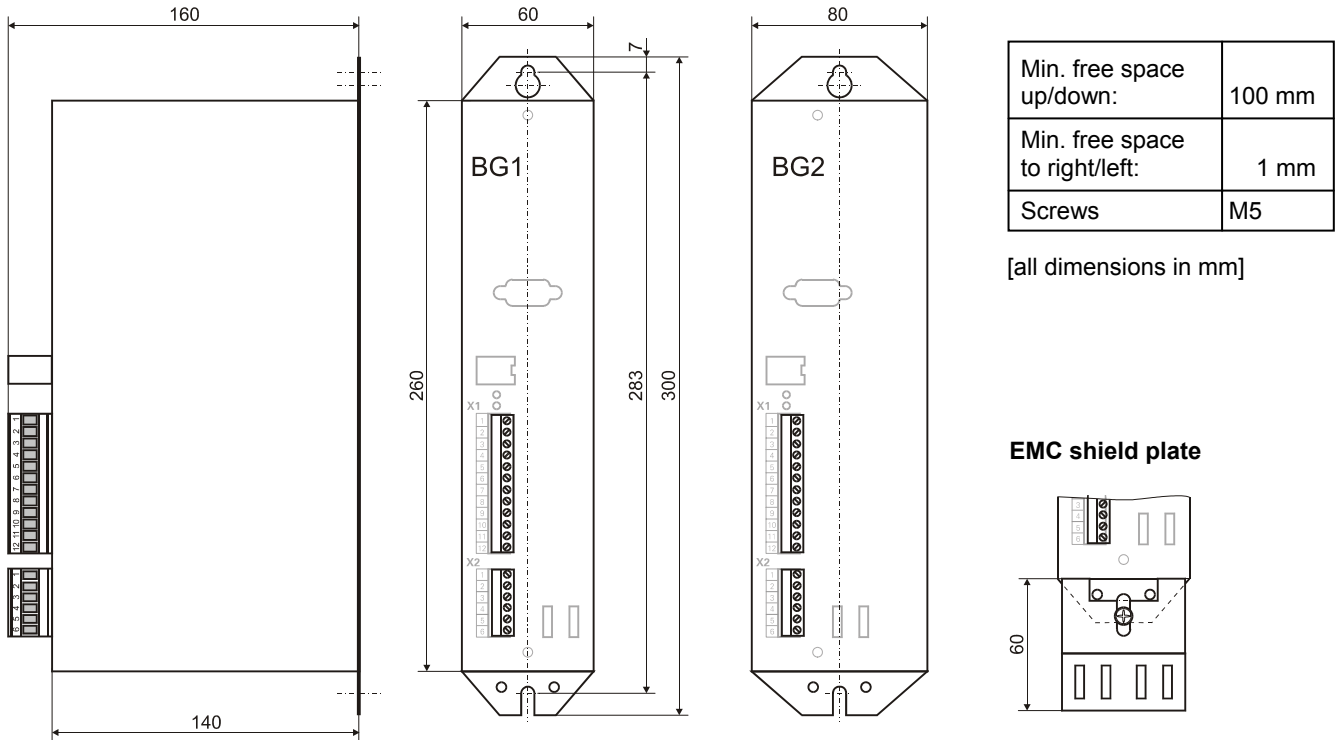

**3.1 Installation site**

- Operate only in closed switching cabinet.
- Install inverter only in vertical position.
- Avoid installation over heat-producing devices.
- Ensure sufficient air circulation in switching cabinet. (Minimum free space of 100 mm over and under the device!)
- Keep installation site free of dust, corrosive fumes and all liquids (in accordance with soil degree 2 in accord. with EN 60204/EN 50178).
- Avoid atmospheric humidity.
- Avoid condensation (e.g., by anti-condensation heaters).
- Use unpainted mounting plates with conductive surface (e.g., unpainted) to conform with EMC regulations.

**4 ELECTRICAL INSTALLATION**

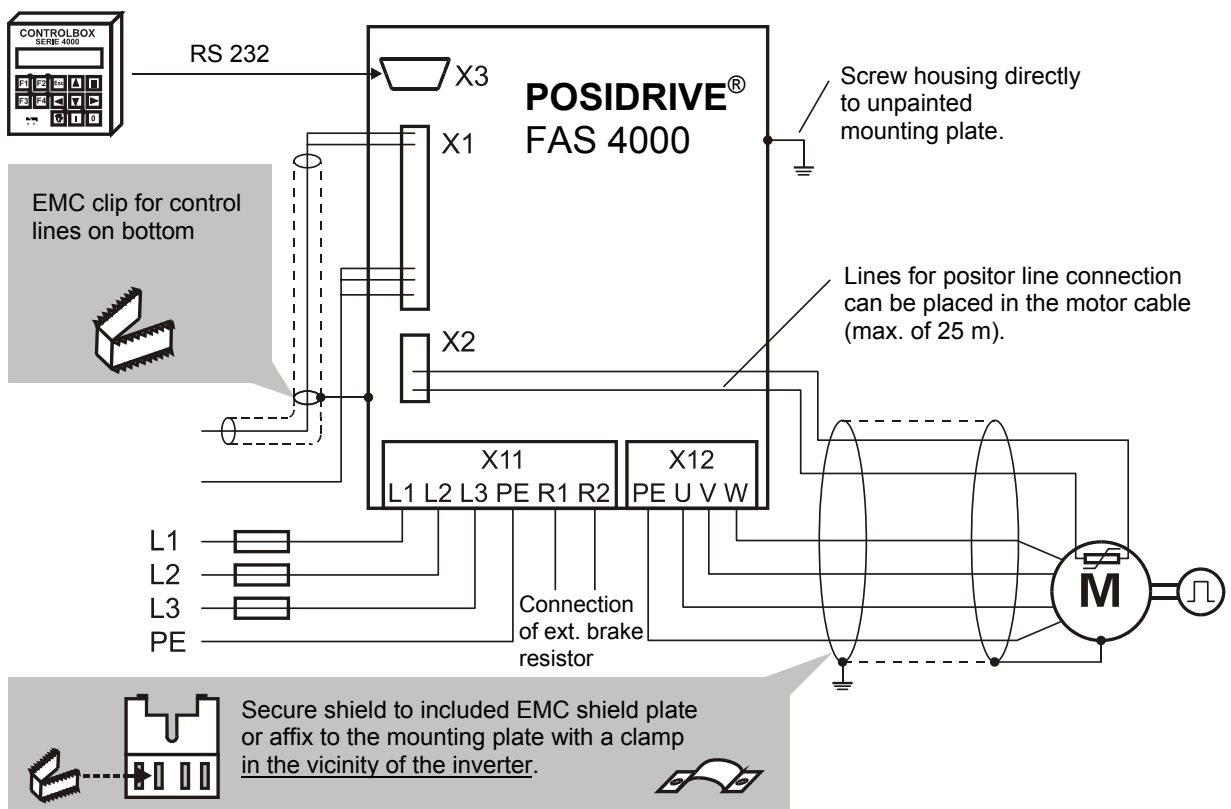

4. Electrical Installation

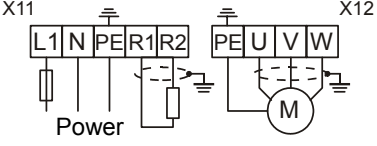
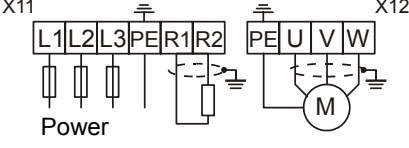
|                     | Terminal Designation |             | Function  | Circuiting   |
|---------------------|----------------------|-------------|---|--|
| Power connector X11 | Single-phase         | Three-phase | Power connection<br><i>Single-phase:</i><br>L1 – N: 1 x 230 VAC +20%/-55% 50/60 Hz  | Single-phase connection<br><br>Three-phase connection<br><br>Shield connection: See below. |
|                     | --                   | L1          | <i>Three-phase:</i><br>L1 – L3: 3 x 400 VAC +28%/-55% 50/60 Hz  |  |
|                     | L1                   | L2          | Protective conductor, power   |  |
|                     | N                    | L3          | Connection of ext. Braking resistance<br><b>With the external brake resistor, we recommend using types with integrated overcurrent relays to prevent thermal damage caused by overload.</b> |  |
|                     | PE                   |             | Protective conductor, motor   |  |
|                     | R1                   |             | Motor connection U, V, W  |  |
|                     | R2                   |             | Adhere to sequence  |  |
| Motor connector X12 | PE                   |             |   |  |
|                     | U                    |             |   |  |
|                     | V                    |             |   |  |
|                     | W                    |             |   |  |

**4.1 EMC-Compatible installation**

**Basic rules**

- Install control and power cables separately (> 20 cm).
- Install power, encoder and motor cables in separate spaces.
- Reference value cables must be shielded and, if necessary, twisted in pairs.
- Connect shield of control lines on one side to the reference ground of the reference value source (PLC, controller, etc.).

**Motor cable**

- Use shielded cables. Apply shield on both sides.
- Use motor derating when cables are longer than 25 m.
- Motor derating is recommended when cables are installed parallel to encoder lines.

**EMC shield plate**

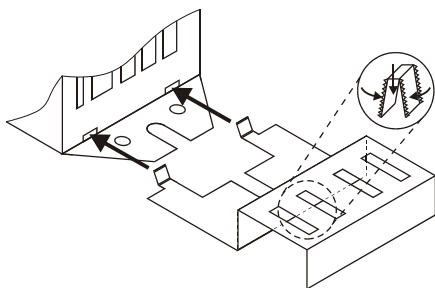

**Sharp edges !**  
To avoid injuries:  
Use suitable tools (e.g., pliers).

Using the two brackets, insert the EMC shield plate slanted (45°) at the location marked on the housing and secure with a screw (not included) together with the frequency inverter.

Secure the motor cable shield to the shield plate with the included EMC clip.

*Top of device*

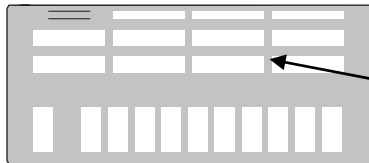

Never install shield terminals along the entire upper side of the device.

**4.2 FI circuit breaker**

Network phases and directly grounded conductor are connected to the protective conductor with Y capacitors. When voltage is present, a leakage current flows over these capacitors to the protective conductor. The greatest leakage current is created when a malfunction occurs (asymmetric feeding over only one phase) and power-on (sudden change in voltage). The maximum leakage current caused by asymmetric powering is 40 mA for FAS inverters. If FI circuit breakers must be used, the problem of power-on and power-off can be minimized by using selective FI circuit breakers (delayed switch-off) or FI circuit breakers with greater triggering currents (e.g. 300 mA). Due to non-sine shaped currents, universal current sensitive components must be used. Use of several devices on one FI circuit breaker is not recommended.



5. Connection Assignment – Control Portion

|                   | Term. | Function  | Circuiting   |   |  |
|-------------------|-------|---|--|---|--|
| Terminal strip X1 | 1     | Internal voltage supply<br>+10 V ±5%, max 3 mA  | <p><i>External voltage</i></p>   | <p><i>Potentiometer</i></p>   |  |
|                   | 2     | Analog input AE<br>0 to ±10 V<br>Resolution: 12 bits <sup>1</sup><br>R <sub>i</sub> = 25 kΩ<br>T <sub>a</sub> = 4 msec                                |  |   |  |
|                   | 3     | Reference potential<br>Analog input AE  |  |   | AE1 function can be programmed under <b>F25</b> .                                    |
|                   | 4     | Analog ground   |  |   | Reference potential for terminals X1.1 to X1.3 and the internal voltage source X1.12 |
|                   | 5     | Digital ground  | Reference potential for terminal X1.6 to X1.11   | <p><b>Tech. data of binary inputs:</b></p> <p>L level:<br/>&lt; +8 V<br/>H level:<br/>≥ +12 V</p> <p>Voltage limits:<br/>-10 V to +32 V</p> <p>Interference immunity<br/>EN 61000-4</p>       |  |
|                   | 6     | Enable<br>T <sub>a</sub> = 4 msec   | Enable power section. See also param. <b>F38</b> .   |   |  |
|                   | 7     | Input BE 1<br>* 8:halt  | <p>Freely programmable, floating inputs. Function is specified with parameters <b>F31</b> to <b>F35</b>.</p> <p>Scan time T<sub>a</sub> = 4 msec. If an incremental encoder is used, max. input frequency on BE4 to BE5 is 80 kHz.</p>   |   |  |
|                   | 8     | Input BE 2<br>* 6:Direction of rotation   |  |   |  |
|                   | 9     | Input BE 3<br>* 1:RV-select0  |  |   |  |
|                   | 10    | Input BE 4<br>* 2:RV-select1  |  |   |  |
|                   | 11    | Input BE 5<br>* 0:inactive  |  |   |  |
|                   | 12    | Internal voltage source <sup>2</sup><br>15 V, 150 mA  | Can be used to control binary inputs X1.6 to X1.11 and to power an incremental encoder. For these uses, the digital ground of the binary inputs (X1.5) must be jumpered with analog ground (X1.4).   |   |  |
| Terminal strip X2 | 1     | Relay 1 (/READY)<br>max. of 6 A/250 V AC<br>6 A/30 V DC ohm. load<br>0.3 A / 30 V DC incl. load, switching time of 15 msec<br>T <sub>a</sub> = 4 msec | <p>Indicates that frequency inverter is ready for operation (i.e., relays closed)<br/>Function can be programmed with <b>F10</b>.<br/>Function response message: <b>E17</b></p> <p><i>Life expectancy (no. of switches):</i><br/>Physical: min. of 30 000 000 times<br/>100 000 x at 250 V AC, 6 A (ohm. load)<br/>300 000 x at 30 V DC, 0.3 A (ohm. load)</p> | <p>If a non purely ohmic load is connected, the relay contacts must be provided with a protective circuit. Use an external coupling relay when greater loads must be switched frequently.</p> |  |
|                   | 2     | Relay 2 (=BA2)<br>Same tech. spec. as relay 1<br>T <sub>a</sub> = 4 msec  |  |   |  |
|                   | 3     | Relay 2 (=BA2)  | Additional relay output, (e.g., for brake control)   |   |  |
|                   | 4     | Same tech. spec. as relay 1<br>T <sub>a</sub> = 4 msec  | Function can be programmed with <b>F00</b> .<br>Function response message: <b>E18</b><br>For brake control, see chap. 8.6.   |   |  |
|                   | 5     | Motor<br>- Temperature sensor (PTC)<br>- Thermal contact (3.2 V, 1 mA max.)   | Connection for one to six positor lines (thermal motor protection). Lines can be installed with the motor cable up to 25 m. If positor lines are not used with a motor, terminals X2.5 to X2.6 must be jumpered.   |   |  |
|                   | 6     |   |  |   |  |

**Remarks:** T<sub>a</sub> = Scan time  
VZ = Sign

\* Parameter setting on delivery

<sup>1</sup> Diff. resolution: 13 bits. Non-linearity: 0.3%. Temp. drift: 0.4%.

<sup>2</sup> Short circuit resistance. Caution: A short circuit may cause a processor reset.

6. Differences from FDS 4000  
7. Operator Control

**6 DIFFERENCES FROM FDS 4000**

Additional functions may be required for the drive design. The POSIDRIVE® FDS 4000 offers the following extra functions.

- Additional second analog input AE2
- Analog input for current (0 to 4 to 20 mA)
- Analog output
- Integrated display and keyboard
- Additional technology functionality
- Can be expanded with option boards
- Optional encoder wire-break recognition
- Power offset with DC link possible
- 50-m motor cable derating inductor permitted
- Power range up to 22 kW

**7 OPERATOR CONTROL**

There are two ways (options) to control and program the POSIDRIVE® FAS frequency inverter.

- External Controlbox operator unit
- PC software FDS Tool

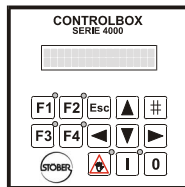

The rest of the commissioning description requires the use of Controlbox. The FDS tool can be used similarly to select the parameters on the appropriate pages.

Controlbox and FDS Tool are optional and are not included with POSIDRIVE® FAS 4000.

**7.1 Operational states**

| LEDs             |   | State of the FAS       |  |
|------------------|---|------------------------|--|
| <b>ERROR Red</b> | ● | OFF                    | No power   |
| <b>RUN Green</b> | ● | OFF                    |  |
| <b>ERROR Red</b> | ● | OFF                    | Device initialization (startup phase) or data action (A00, A01, A03 or A40 are active)<br>Paramodule is not correctly installed. |
| <b>RUN Green</b> | ☀ | Flashing at 8 Hz       |  |
| <b>ERROR Red</b> | ● | OFF                    | Ready for operation (not enabled)  |
| <b>RUN Green</b> | ☀ | Flashing evenly (1 Hz) |  |
| <b>ERROR Red</b> | ● | OFF                    | Operation (enabled)  |
| <b>RUN Green</b> | ☀ | ON                     |  |
| <b>ERROR Red</b> | ☀ | Flashing evenly (1 Hz) | Warning  |
| <b>RUN Green</b> | ☀ | ON or flashing         |  |
| <b>ERROR Red</b> | ☀ | ON                     | Malfunction  |
| <b>RUN Green</b> | ● | OFF                    |  |

**7.2 Paramodule**

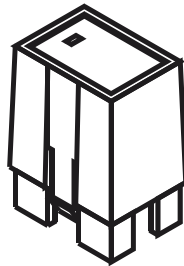

The device parameters are stored on the removable red Paramodule on the front plate of the FAS 4000. This makes commissioning the new device easy when an inverter has to be changed. Just by moving the Paramodule from the old, already parameterized inverter to the new device, the new device automatically uses the old parameters.

This also applies to bus address **A83**, for instance. The Paramodule runs parallel to the internal backup memory. When the parameter value **A00** changes from 0 → 1, the current parameters are stored in the internal memory and in Paramodule. After power-up, the data records are read from Paramodule and automatically stored internally. A Paramodule with the default setting is recognized by **E56=0** and **E57=0**. When a Paramodule is installed on an already programmed inverter and the power is turned on, the parameters are taken from the backup memory of the inverter and stored on the Paramodule. The Paramodule can also be installed or removed while the inverter is on.

We recommend labelling the front of the Paramodule with the machine or drive ID. The labels for this are included.

If position control is used for the POSIDRIVE® FAS 4000 (optional POSI upgrade module, cat. no. 27355), the additional upgrade code is also stored on Paramodule. This is used when the inverter is exchanged.

An automatic internal data offset takes place each time the power is turned on. The user usually does not even notice this. The offset is concluded after approx. 30 seconds. However, during this time, the actions **A00, A01, A02, A03, A04, A37, A40, A42, A43, B40, B41, J00, J01** and **J04** cannot be executed.

**7.3 Controlbox**

As an external operator unit, Controlbox offers an easy-to-use menu system in plain text. It is fully compatible with STÖBER FDS 4000 frequency inverters. Controlbox is available in two models: Controlbox in the hand-held housing and Controlbox in the DIN built-in housing (96 x 96 mm). In addition, the Simubox.exe program is available to simulate Controlbox on a PC.

These three keys are available for commissioning.

Switches to local operator control and back. The drive stops (internal enable = off). An appears on the bottom right of the display. **A55** (manual key function) must be active.

Enable = turn on with local operator control. The drive is in the state 5:halt and can be controlled with the arrow keys and .

Enable = off with local operator control  
If not already active, local operator control is activated (i.e., the drive stops).

Controlbox offers memory space for the parameters of up to 7 FAS frequency inverters. The inverter data are written in Controlbox as shown below.

- Select the memory location number (1 to 7) in **A03** (write Parabox). The data record name is indicated.
- Press the key.

## 7. Operator Control

The data are read from Controlbox to the inverter in a similar manner.

- The memory location number in **A01** (read Parabox & store)
- Press the **#** key.

The data are not automatically stored with **A40** (read Parabox).

Direct exchange of parameters between Controlbox and a PC is also possible.

### 7.3.1 Operation indication

In its default setting, the visible *operation indication* on the display of a Controlbox is set up as shown below.

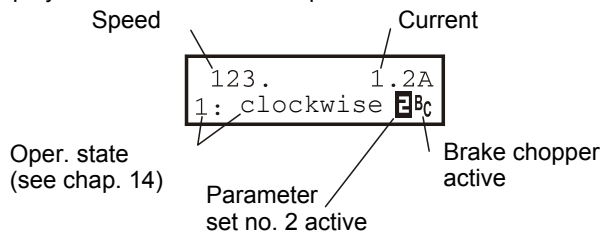

All possible operational states are listed in chap. 14. When **B** is on, the inverter is using parameter record no. 2. No special indication is provided when parameter record no. 1 is active (default setting). **Bc** appears when the brake chopper is activated.

**C51** can be used to convert the speed (e.g., to gear output). In control mode V/f control (**B20=0**) and sensorless vector (**B20=1**), the post ramp reference value is indicated as the speed. For vector control with speed feedback (**B20=2**), the measured actual speed is indicated.

The first line of the display can also be customized. A variable selected via **C50** (e.g., power) is divided by **C51** and provided with the unit in **C53** (e.g., "items/min"). The unit can only be specified via FDS Tool. The number of positions after the decimal point is provided by **C52**.

### 7.3.2 Parameterization

- Return to prev. menu level
- Reject changes
- Acknowledgment of mal-functions (**A31=1**)
- Select various menu levels
- Accept changes

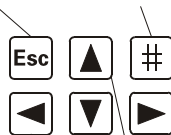

- Group selection
- Parameter selection
- Edit parameters

To program, press the **#** key (Enter). The menu consists of several **groups** which are identified with the letters **A**, **B**, **C** and so on. Select the groups with the arrow keys (i.e., **◀** and **▶**). Press the **#** key again to access the parameters of the selected group.

The parameters are designated with the group letters and a number (e.g., **A10** or **D02**).

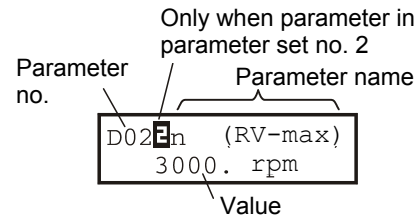

Parameters are selected with the **▲** and **▼** keys. To change a parameter, press the **#** key again. The flashing value can now be changed with **▲** and **▼**. The changes take effect immediately. To retain the changed value, press the **#** key. To reject the change, press the **Esc** key. To return from parameter selection to the group letters, press **Esc**. To return to the status display, press **Esc** again.

**Parameter changes must be saved with A00=1 (save parameters) before the device is turned off.**

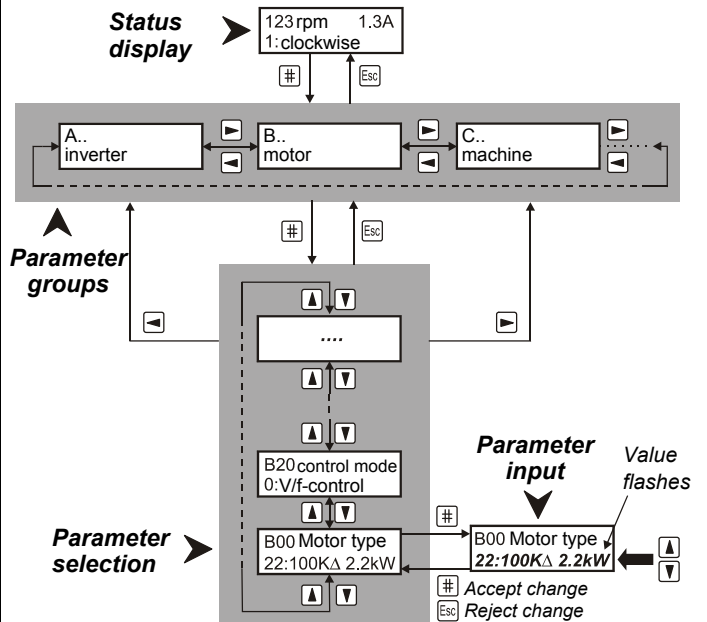

After power-on, the inverter only shows the most important parameters which are required for commissioning. To solve complex drive tasks:

**A10=01:** Activate *expanded menu*

**A10=2:** Service; Access to rarely used service parameters

Both the normal menu and the expanded menu do not show parameters which are not related to the current task.

**Example:** When a predefined STÖBER motor (e.g., 100KΔ2.2kW) is selected in parameter **B00** (motor type), parameters **B10** to **B16** (poles ... cos PHI) are not shown.

Approximately 50 sec after the last key was pressed, the device returns automatically to the status display. This return can be prevented with **A15=0** (auto return inactive).

**Fieldbus: The most of the parameters pertaining to the fieldbus can only be set on the PC with FDS Tool.**

## 8. Commissioning (with Controlbox)

### 7.3.3 Password

The parameters can be protected against unauthorized change. To do this, enter a password (an up to 4-digit number other than zero) in parameter **A14**, and save it with **A00=1**. Password protection is inactive if **A14=0**. Parameter **A14** can only be accessed in the extended menu with **A10=1**.

On a protected device, the parameters can only be changed after the correct password has been entered in **A13**.

## 8 COMMISSIONING (WITH CONTROLBOX)

The power connections (i.e., power supply and motor) must first be correctly wired in accordance with chap. 4. Before initial commissioning with a reference value potentiometer, the following circuiting must be made.

- Reference value specification via potentiometer (X1.1 to X1.4), see chap. 5.
- Enable (terminal X 1.6)
- Temperature sensor (terminals X2.5 and X2.6), see chap. 5.

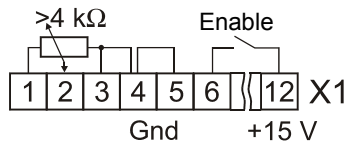

If no temperature sensor exists, X2.5 and X2.6 must be jumpered. The internal 15 V voltage on X1.12 can be used to power the control signals. This requires a jumper between X1.4 and X1.5. Motor and inverter must be adjusted to each other. To do this, select the appropriate motor type in parameter **B00**. See chap. 8.2.

### 8.1 Primary parameters

When connected to the power supply, the status display shows status "0:Ready for operation." If "12:Inhibited" is shown instead, the enable must be removed. The following parameters must then be specified.

- **A20**: (braking resistor type) if present
- **B00**: (motor type stated on nameplate). See chapter 8.2.
- **B20**: (control mode) can usually be left as "1:Sensorless Vector." Speed accuracy and dynamics are better here than classic *V/f control* (**B20=0**).  
For vector control with n feedback, see chapter 9.6.
- **C00**: (min. speed), **C01** (max. speed)
- **D00**, **D01**: Acceleration and deceleration ramp
- **D02**: Speed at 100% reference value (10 V on AE1)

"Check entries" is started with **A02=1**. Any contradictions in the parameterization are reported.

⇒ Remember to save the parameters with **A00=1** before turning off the power.

### 8.2 Motor type

Most 4-pole STÖBER motors can be specified directly in the **B00** parameter:

**Example:** For drive C602N0620MR1 D100K 4 TF (100K, 4-pole motor) either "17:100KY2.2kW" or "18:100KD2.2kW" is entered in **B00** depending on the circuiting (i.e., star or delta).

⇒ When a concrete motor type is specified, no further settings (e.g., break point, nominal current and similar) are necessary.

The following applies to STÖBER motors up to a size of 112 (i.e., 4 kW).

With the star connection (Y), the nominal voltage is reached at 50 Hz, while with the delta connection (Δ) the nominal voltage is reached at 87 Hz. With the star connection, full motor torque is available up to 50 Hz, while with the delta connection full motor torque is available up to 87 Hz.

If motors are not predefined (e.g., motors of other manufacturers or the number of poles is not 4), **B00** must be set to "0:user defined." Parameters **B10** to **B16** must be set manually based on the motor's nameplate. FDS Tool has an **external motor data base** for non-STÖBER, user-defined motors. Your own motors can be added to the motors which are predefined there.

**⚠ B00=0** must be used for motors with special winding (e.g., motor 132 with 230/400 V). The *V/f* characteristic curve (i.e., the relationship between voltage and frequency) is specified by the parameters **B14** (nominal voltage) and **B15** (nominal frequency). Additional specification of the break point is not necessary. As the frequency rises, the voltage increases past **B14** up to the available power voltage or **A36**. The motor must then be autotuned with **B41=1** as shown below.

1. Set **B41=1**. Default display is 0%.
2. Activate enable. Measuring begins.
3. When 100% is reached, remove enable. Measurement is concluded.

⇒ Save parameters with **A00=1** before turning off the power.

⇒ When the FDS tool is used, the edited parameters must be stored on the inverter before autotuning.

### 8.3 Reference value via controlbox

For a function test during commissioning, it is sufficient to circuit enable input X1.6 and the terminals for temperature sensors X2.5 and X2.6. The speed is specified with the keyboard. Set **A50=1** (tip active), and activate **A51** with **[#]** so that the speed reference value flashes. Speed **A51** is used until the next time **[#]** or **[Esc]** is pressed. The speed can be changed with **[▲]** and **[▼]**.

An alternate method when **A50=1** is flashing (entry after **[#]**) is to use the **[◀]** and **[▶]** keys to move the drive (classical tip mode). The tipping speed can be adjusted with **A51** (set **A50=0** beforehand or the drive will start running).

The frequency inverter can also be operated directly via Controlbox without extra circuiting. The device is enabled with the keys manual operation **[⚠]** and ON **[I]**. You can then continue with the direction keys **[◀]** and **[▶]**. The tipping speed can also be adjusted here with **A51** (set **A50=0** first, or the drive will start).

### 8.4 Analog/frequency reference value

With the default setting, the speed can be specified immediately via the reference value on analog input AE1 (e.g., via potentiometer, cf. page 5). The following other parameters are also of interest here:

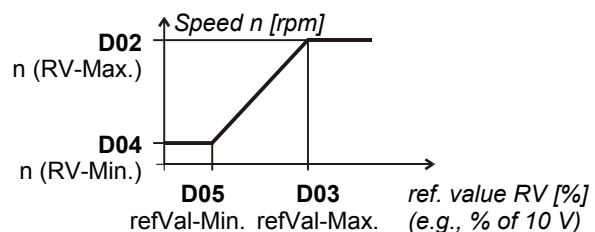

## 9. Special Functions

- **D02:** n (RV-Max) Speed at maximum reference value (10 V or f-max)
- **E10:** AE1-level Indication in % of the final value (final value=10 V)

With the extended menu (**A10=1**), the following parameters are also available.

- **D03:** refVal-Max. Maximum reference value in % of the final value (final value = 10 V or f-max). For example, with **D03=50%**, the speed set in **D02** is achieved at 5 V.
- **D04:** n (RV-Min.) Speed at minimum reference value
- **D05:** refVal-Min. Minimum reference value in % of the final value
- **D06:** refVal-offset Offset on AE1 in % of the final value

Parameters **D02** to **D05** can be used to specify as desired the relationship between the analog reference value (usually the voltage) and the speed in the form of a reference value characteristic curve as shown below.

The reference value is voltage (100%=10 V) or frequency (f-max=100%=Par. **F37**). The frequency reference value is activated by **F35=14**. The frequency signal must be available on BE5. The ramps for the analog and frequency reference value are specified by **D00** and **D01**. **D92=1** negates the reference value. When **D07=1**, the controller enable depends on the reference value.

See block circuit diagram of the reference value processing in chapter 16.

### 8.5 Fixed reference values (digital ref. val.)

Up to 7 fixed reference values (FRV) can be defined. Switchover is binary-coded via binary inputs. With the *default setting*, inputs BE3 and BE4 are provided for the selection of three fixed reference values.

| BE4 | BE3 | Reference Value                | E60 | Ramps           |
|-----|-----|--------------------------------|-----|-----------------|
| L   | L   | Analog / frequency             | 0   | <b>D00, D01</b> |
| L   | H   | Fixed ref. value 1, <b>D12</b> | 1   | <b>D10, D11</b> |
| H   | L   | Fixed ref. value 2, <b>D22</b> | 2   | <b>D20, D21</b> |
| H   | H   | Fixed ref. value 3, <b>D32</b> | 3   | <b>D30, D31</b> |

The speed in **D12, D22**, etc. is entered in motor rpm. The input signals are fed to a reference value selector and binary decoded there. The result of the binary decoding (i.e., 0 to 7) is indicated in parameter **E60**.

⇒ If the result of binary decoding is 0 (**E60=0**, i.e., L level on all inputs of the RV selector), the analog/frequency reference value is also taken into consideration.

The binary inputs can be allocated as desired to the input signals of the reference value selector. With the default setting, **F33=1** (BE3 function=RV select0) and **F34=2** (BE4 function=RV select1) apply. RV select0 and RV select1 correspond to bits 0 and 1 of the binary reference value selector. If no binary input is assigned to one of the three refVal select signals, this signal is considered low. To use all 7 fixed reference values, input BE5 could be programmed to **F35=3** (RV select2), for example. The selected ref. value is negated with **D92=1** (i.e., the direction of rotation is reversed). The fixed ref. value number can be specified directly with **D09**.

### 8.6 Brake control

Relay 2 is programmed with **F00=1** for brake control. The brake is applied under the following conditions.

- Removal of the enable. Watch **F38=1**.
- Halt. One BE must be programmed to HALT (e.g., **F31=8**).
- Quick stop (e.g., with BE function "9:quick stop")

- Halt or quick stop with BE functions "clockwise V3.2" and "counter-clockwise V3.2" (both signals on "L" or "H").
- Fault. Watch **F38=2**.

The brake can be released manually with BE function "**32: brakeRelease**."

During operation without speed feedback (i.e., **B20 < 2**), **F01** and **F02** are used to define the speed limit to open and close the brakes.

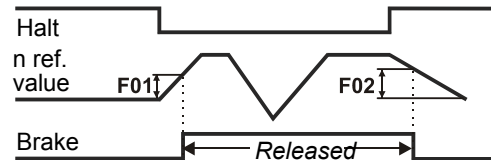

With vector control (**B20=2**), **F00=1** can be used for full brake control in lifting systems. The release time **F06** and application time **F07** of the brake must be specified with an additional amount for the relay delay time (10 to 30 msec). When one of the above events occurs, the drive remains controlled for the time **F07**. During traversing, startup is delayed by the time **F06**.

The magnetizing current can be turned off or reduced ("econo mode," parameter **B25**) when halt is active.

**⚠ 24 V brakes** may not be controlled directly with relay 2. Use an external auxiliary relay instead!

### 8.7 Parameter transmission

Controlbox or the FDS Tool PC software can be used to read or store parameters from the inverters. Transmission to other inverters is possible. Data records can also be read from Controlbox to a PC. Controlbox must be powered with an external source of voltage.

Controlbox offers memory space for the parameters of up to 7 devices. The inverter data are written to Controlbox as shown below.

- Select the memory space number (1 to 7) in **A03** (write Parabox).
- Press **#**.

The data are read from Controlbox to the inverter in a similar manner.

- Select memory space number with **#** in **A01** (read Parabox & save).

There is no automatic saving with **A40** (read Parabox).

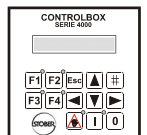

## 9 SPECIAL FUNCTIONS

### 9.1 Binary inputs BE1 to BE5

With the default setting, the binary inputs which can be programmed as desired have the following meaning.

- BE1 = 8:Halt
- BE2 = 6:Direction of rotation (left/right)
- BE3 = 1: RV select0 (bit 0, fixed reference value decoding)
- BE4 = 2: RV select1 (bit 1, fixed reference value decoding)
- BE5 = 0:Inactive

The function of the binary inputs is specified via the parameters **F31** to **F35** in the extended menu (**A10=1**).

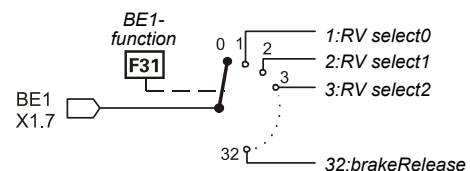

## 9. Special Functions

When several inputs are connected to one function, the signals are either AND or OR-linked (**F30** BE-logic). Functions without a connection to a BE signal are provided internally with an L-level signal.

### 9.2 Torque limits

There are several methods of limiting motor torque.

- In the default setting, **C03** (M-Max 1) is the current torque limit in % of nominal motor torque.
- A binary input (assign BE funct. "10:torque select" via one of the param. **F31** to **F35**) can be used to switch between the two torque limits **C03** (M-Max 1) and **C04** (M-Max 2).
- During startup mode **C20=2** (cycle characteristic), switching between **C03** (M-Max 1) and **C04** (M-Max 2) is automatic. M-Max 1 is used during constant travel, while M-Max 2 is used during acceleration phases.
- Analog input AE1 can also be used to limit torque. Set parameter **F25=2.10** V corresponds to 100% nominal motor torque. Other scaling is available via **F27** (AE1 gain).
- With quick stop, **C04** (M-Max) always takes effect.

The actually effective torque limit is calculated from the minimum of the various limit values. It can be scanned in parameter **E62**.

⇒ Torque limitation is the most precise in speed feedback mode. Accuracy here is  $\pm 5\%$  of nominal torque. In the classical control mode *V/f control* (parameter **B20=0**), torque calculation is not very accurate with low speeds and small loads. Results with control mode *Sensorless Vector Control* (**B20=1**, default setting) are better than with *V/f control*.

Particularly in control mode *Sensorless Vector Control*, the dynamics can be improved by estimating the ratio of inertia **C30** (J-mach/J-motor) and setting it accordingly. **C30=0** (default setting) applies if the driven inertia is low or if the gear ratio is high.

⇒ We all know that the relationship between current and torque is not easy to determine for asynchronous motors. Since an FAS inverter is able to calculate the torque from available measured data, the maximum torque is specified and not the maximum current. Maximum available torque is always limited by the maximum inverter current.

### 9.3 Operating range

Freely programmable comparators can be used to simultaneously monitor 3 measured values (i.e., "operating range"). The first 2 values (speed and torque) are fixed. The third value can be selected as desired with **C47**. The limit values are specified with the following parameters.

- **C41, C42**: n-Min, n-Max
- **C43, C44**: M-Min, M-Max
- **C45, C46**: Measured value "X" (specified in **C47**)

**C48=1** monitors the absolute value of measured value "X" (**C47**). **C48=0** also includes the sign. Parameter **C49** specifies whether monitoring is also to take place during acceleration phases and enable-off. When at least one of the limits is exceeded, this can be signaled on the binary output (relay 2) with the "6:operation range" function (e.g., **F00=6**).

If only one or two of these range monitoring options are used, the limits of the unused ranges must be set to their limit values (e.g., **C43=0%** and **C44=400%** when torque monitoring is not required).

### 9.4 Parameter record switchover

The FAS inverter supports two separate parameter records. Specification of the active parameter record is performed in one of the following ways.

- Via a binary input (**A41=0**)
- Via Controlbox (**A41=1** or 2)

The active parameter record is indicated in **E84**. To specify via a binary input, one of the parameters **F31** to **F35** must be set to "11:paraSet-select" *in both parameter records*. Selection never takes place unless the power section is deactivated.

The parameters of both parameter records can be indicated and programmed regardless of which parameter record is currently active. **A11** (paraSet Edit) is used to specify the parameter record (1 or 2) to be edited. When parameters of the 2nd record are involved (**A11=2**), a **E** is indicated to the right of the parameter number.

Certain parameters (e.g., operation input, **A30**) are only available once, and a **E** is then not indicated next to the parameter number. This applies to all parameters of group **A** and the display parameters of group **E** (e.g., torque, utilization and similar).

Example of time behavior with quick stop for enable-off (**F38=1**. For release, see also **F31=11**).

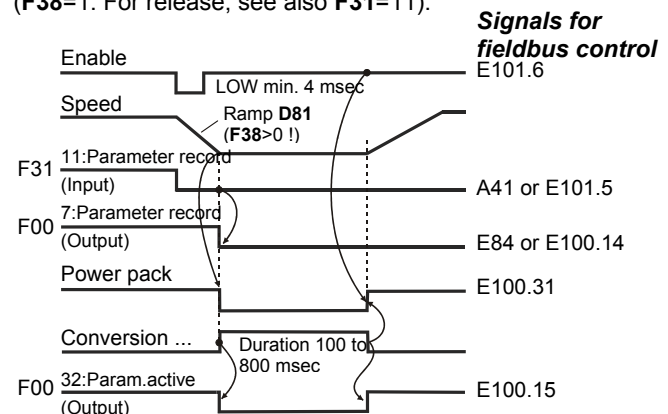

When autostart is active (**A34=1**), the switchover takes place immediately when the edge of the signal "11:Paraset" occurs. Enabling is automatically deactivated internally.

Parameter records can be copied via **A42** and **A43** (copy paraSet). **A42**: copy paraSet 1 > 2 on "1:active" overwrites parameter record 2 with the values of parameter record 1.

⇒ Usually, the first parameter record should be commissioned first. The parameters are then copied to parameter record 2 with **A42=1** (active). **A11=2** is then used to switch to parameter record 2 and edit the necessary values there. After completion, all parameters are saved with **A00=1**.

### 9.5 Motor potentiometer

The "motor potentiometer function" can be used to steplessly increase or decrease the motor speed via two binary inputs.

- Two binary inputs are programmed to "4:motorpoti up" or "5:motorpoti dwn" via **F31** to **F35**.
- The "motorpoti function" is activated with **D90=1**.
- When the key is pressed, the speed is changed in accordance with the ramps in **D00** and **D01**. When the "motorpoti function" is active (**D90=1**), most of the parameters of group **D** (reference values) are not indicated.
- The maximum speed corresponds to the value set in **C01**.

## 9. Special Functions

- **D90=2** causes the motor potentiometer to be added to the normal reference value.
- The reference value generated by the motor potentiometer is set to **C00** (n-Min) if both BE inputs are high.
- With **D91=0**, the reference value which was approached last is stored non-volatily.
- With **D91=1**, the motor potentiometer reference value is reset with enable-off.

### 9.6 Speed feedback

Standard FAS inverters support speed feedback via an incremental encoder (HTL). Control mode **B20=2** (vector control with 2-track feedback) provides precise and highly dynamic control of speed and torque (i.e., asynchronous servo drive). To commission speed feedback, proceed as shown below.

#### ■ Wiring:

Incremental encoder tracks A and B are connected to binary inputs BE4 and BE5. The encoder can be connected to the inverter directly.

| En-coder Pin | Color of STÖBER Cable | En-coder Signal | Binary Input         | Connection      |
|--------------|-----------------------|-----------------|----------------------|-----------------|
| 1            | Yellow                | /B              |                      |                 |
| 3            | Pink                  | C               | BE3                  | X 1.9           |
| 4            | Gray                  | /C              |                      |                 |
| 5            | Brown                 | A               | BE4                  | X 1.10          |
| 6            | White                 | /A              |                      |                 |
| 8            | Green                 | B               | BE5                  | X 1.11          |
| 9            | --                    | Shield          |                      | Shield terminal |
| 10           | Blue                  | 0 V             | 0 V internal         | X 1.5           |
| 12           | Red                   | +U <sub>B</sub> | + 15 V/150 mA of FAS | X 1.12          |

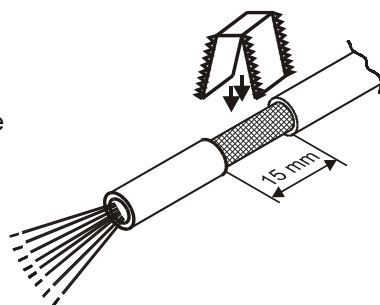
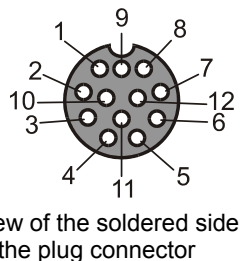
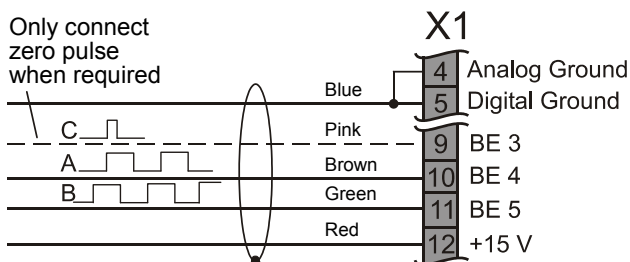

- With regard to EMC requirements, it is better to connect tracks A, B and C directly and not with terminal blocks.
- **F34=14** and **F35=15** are used to program binary inputs BE4 and BE5 for speed feedback. Activate extended menu with **A10=1** first.
- If necessary, **F36** can be used to change the increment number of the encoder (default setting: 1024 incr/rotation).

#### ■ External encoder behind the gearbox

- The motor can also always be controlled with an encoder directly on the machine.
- The number of increments converted to the motor shaft must be entered in **F36**.



**Caution:** A connection between motor and external encoder in which there is vibration, play or slip may cause problems with control. The resolution converted to the motor shaft should be at least 500 increments.

#### Checking the wiring

- In control mode *U/f control* or *Sensorless Vector* (**B20=0** or 1), let motor rotate, and make a note of the speed (with sign). Look at the actual speed in parameter **E15** (n-Encoder). The speed should be similar to that shown in the status indication. In particular, the **sign** must be the same.

#### Possible problems

**Sign is wrong:** Check motor connection (sequence of the phases), and reverse signals A and B of the encoder, if necessary.

**0 rpms indicated in E15:** Is V<sub>B</sub> applied to the encoder with the correct polarity? Is the grounding connection okay? Are there other wiring errors? Are **F34** and **F35** programmed correctly? Signals A and B can be checked separately. Stop the motor, and look at parameter **E13**. Even the slightest motor rotation (e.g., by turning the fan wheel manually) must cause the level of BE4 and BE5 to change.

#### Activating vector control

- Stop motor, and select control mode **B20=2** (vector control).
- Let motor rotate. If problems occur, check the above items again.
- Save parameters with **A00=1**.
- ⇒ If the sign of speed feedback is wrong, the motor rotates slowly and does not react to reference values. Or the fault "33:overcurrent" is reported.
- The dynamics of the speed control circuit are primarily dependent on parameters **C31** (n-controller K<sub>p</sub>) and **C32** (n-controller K<sub>i</sub>). They determine proportional and integral gain of speed control. Excessive gain causes the motor to vibrate, while insufficient gain reduces dynamics. The default setting can usually be retained. If necessary, adjust **C31** first. **C32** affects the "load capability." With large external masses or overswing, **C32** may have to be reduced (2 to 30%).

## 10. Positioning Control

### 9.7 Acknowledgment of malfunctions

The table of possible faults is located in chap. 15. Faults are acknowledged in the following ways.

- Enable: Change from L to H level on the enable input, and then back to L. Always available.
-  - key of Controlbox (only when A31=1)
- **Auto reset** (only when A32=1)
- **Binary input (F31 to F35=13)**

 **Caution!** Drive starts up immediately.

Parameters **E40** and **E41** can be used to scan the last 10 faults. Value 1 represents the last fault. FDS Tool can be used to assign as desired the inverter reaction (e.g., fault, warning, message or nothing) to certain events. Cf. chap. 15.

### 9.8 Motor startup



- The autostart function can be used to permit the drive to start up immediately after the power is turned on (cf. chap. 13).  
**Before the autostart A34=1 is activated, it must be ensured that the automatic startup cannot cause hazardous system states!**
- **C20=1** (load start), **C21** and **C22** can be used to specify an overload to be tolerated when sluggish machines start up (*V/f control*).
- **C20=2** (cycle characteristic) is used to obtain optimum acceleration with *Sensorless Vector Control (B20=1)*. For more information, see also parameter **C30** and chapter 9.2.

### 9.9 Control via PC

The **FDS Tool** software can be used to control the frequency inverter with a PC. The inverter is connected to the PC with sub D plug connector X3 (RS 232-C interface) and FDS cable G3 (cat. no. 41488).

With its integrated **FDS Scope** feature (oscilloscope function), FDS Tool permits eight different measured variables to be recorded at the same time to optimize the drive.

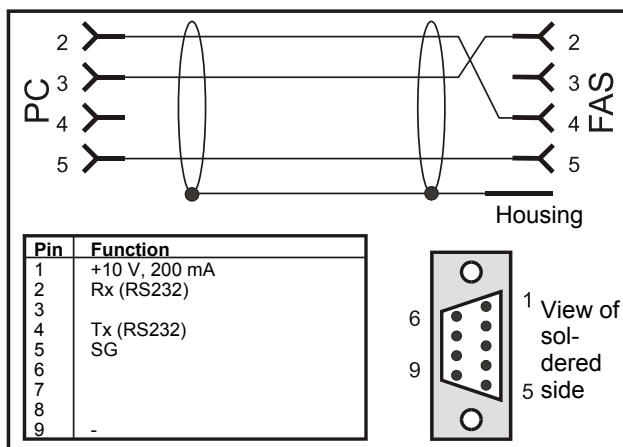

#### FDS cable G3, cat. no. 41488

Connection cable between the serial interface of the PC (Notebook) and serial interface X3 of the FAS. May NOT be replaced with a conventional serial connection cable.

The +10 V on pin 1 is exclusively to power a Kommubox and/or a Controlbox.

**Caution:** A brief short circuit against ground can cause a brief reset of the processor.

The RS 232 interface can be used to create a low-cost network of several inverters with an "RS 232 ring."

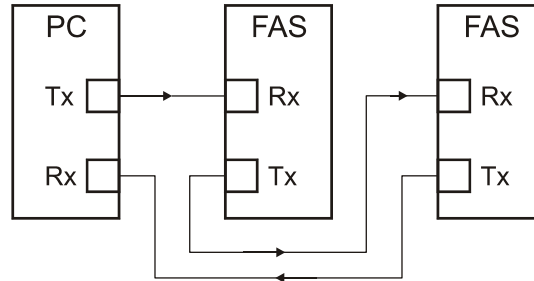

Networking with an RS 232 ring is supported by FDS Tool.

The RS232 ring can be used to control the inverters by communication via USS protocol.

For more information on the USS protocol, see the USS documentation (no. 441564).

## 10 POSITIONING CONTROL

The **POSI upgrade module** (cat. no. 27355) makes it possible to upgrade to a complete single-axis positioning control. Particularly when used with a fieldbus, this controller shows off its full range of powerful features.

Among others, the following functions are available to the user.

- Destination travel to precise increment in VC mode
- Continuous position control with following error monitoring (VC).
- In control mode SLVC: Position control can also be used without encoder.
- Positions in 8 process blocks can be programmed.
- Rotary axis function of gear transmission with specification of both axle numbers
- Parameterization with units specified (e.g., in degrees and mm)
- Reference traversing with several modes
- Manual operation (inching)
- Teach in function
- Speed override via analog input
- Hardware and software proximity switch



11. Parameter Description

| A.. Inverter  |   | E   |   |  |
|---|---|---|---|--|
| Para. No.   | Description   |   |   |  |
| A00 <sup>1)</sup>   | <p><b>Save parameter:</b><br/>                     0: inactive;<br/>                     1: The parameters of both parameter records are saved in non-volatile memory. Saving is triggered when the value changes from 0 to 1. "<b>A02 check parameter</b>" is then performed automatically.</p>  |   |   |  |
| A01•  | <p><b>Read parabox &amp; save:</b> Read parameters from Controlbox and save in non-volatile memory. First select desired data record (1 to 7), and then press <b>#</b>.<br/>                     "A02 check parameter" is started automatically. When read errors occur, all parameters are rejected, and the settings last saved with <b>A00</b> are restored.<br/>                     0: inactive;<br/>                     1 to 7; <b>Controlbox</b> (number of the data record)</p>  |   |   |  |
| A02 <sup>1)</sup>   | <p><b>Check parameter:</b> Parameterization is checked for correctness. For possible results, see chap. 13.<br/>                     0: inactive;<br/>                     1: active; Parameters of the parameter record to be edited (see <b>A11</b>) are checked for the following.<br/>                     - Adherence to the value range<br/>                     - (n-Max / 60) x encoder incr. &lt; 80 kHz. [(C01 / 60) x F36 &lt; 80 kHz]<br/>                     - Correct programming of the binary inputs (F31 to F35)<br/>                     - If control mode "vector-controlled with 2-track feedback" has been selected with <b>B20=2</b>, BE4 must be programmed to encoder track A (F34=14) and BE5 must be programmed to encoder track B (F35=15).</p>   |   |   |  |
| A03 <sup>1)</sup>   | <p><b>Write to parabox:</b> Write data of the inverter to external data medium (Controlbox)<br/>                     0: inactive;<br/>                     1 to 7; The parameters of both parameter records are copied from the inverter to Controlbox. For handling, see <b>A01</b>.</p>   |   |   |  |
| A04• <sup>1)</sup>  | <p><b>Default settings:</b> All parameters are reset to their default settings.<br/>                     0: inactive;<br/>                     1: active; The procedure is triggered when the value changes from 0 to 1.</p>  |   |   |  |
| A10   | <p><b>Menu level:</b> Specifies the parameters which can be accessed by the user<br/>                     0: standard; Parameters which can be accessed are highlighted in gray. All parameters remain in effect including those in the "1:extended" menu level.<br/>                     1: extended; Access to all parameters which can be set<br/>                     2: service; Access to rarely used service parameters. Small print (e.g., <b>A37</b>).</p>   |   |   |  |
| A11   | <p><b>Parameter set edit:</b> Specifies the parameter record to be edited. The parameter record to be edited (<b>A11</b>) and the active parameter record (status indication) do not have to be identical. For example, parameter record 1 can be edited while the inverter continues operation with parameter record 2. See also chapter 9.4.<br/>                     1: parameter set 1; Parameter record 1 is edited.<br/>                     2: parameter set 2; Parameter record 2 is edited.</p>  |   |   |  |
| A12   | <p><b>Language:</b> When the language is changed, FDS-Tool-specific texts <b>U22</b>, <b>U32</b>, <b>U42</b> and <b>U52</b> are reset to the default setting. This also applies to <b>C53</b>.<br/>                     0: German;                      1: English;                      2: French;</p>   |   |   |  |
| A13   | <p><b>Set password:</b> Password is requested. If a password is defined in <b>A14</b>, this must be entered here before parameters can be changed. See chapter 7.3. If parameterized with FDS Tool, no password required.</p>   |   |   |  |
| A14   | <p><b>Edit password:</b> Definition and modification of the password. 0 means that no password has been set. All other values are valid passwords. See chapter 7.3.3. A defined password can only be read out via FDS Tool and only entered with Controlbox.</p>  |   |   |  |
| A15   | <p><b>Auto-return:</b> Permits automatic return from the menu to the status indication. In edit mode (i.e., the edited parameter is flashing), there is no automatic return to the status indication.<br/>                     0: inactive;<br/>                     1: active; If 50 seconds pass without a key being pressed, the display jumps back to the status indication.</p>  |   |   |  |
| A20   | <p><b>Braking resistor type:</b> Specification of the braking resistor type<br/>                     0: inactive; Braking transistor is deactivated. Too much braking energy causes fault "36:overcurrent."<br/>                     1: user defined; For resistor values, see <b>A 21</b>, <b>A22</b> and <b>A23</b>. Entering <b>A20=1</b> and <b>A22=0</b> automatically extends the braking ramps when DC link voltage is too high.</p> <table border="1" style="margin-left: 20px;"> <tr> <td style="padding: 5px;">                     2: 300Ohm0.15kW<br/>                     3: 200Ohm0.15kW<br/>                     4: 100Ohm0.15kW<br/>                     5: 100Ohm0.6kW                 </td> <td style="padding: 5px;">                     } <b>A20</b> 1 to 5: This information is used to create a thermal model which determines the maximum permissible power which can be dissipated with the braking resistor. This protects the braking resistance from thermal overload. A thermal overload causes the fault "42:Temp.BrakeRes."                 </td> </tr> </table> | 2: 300Ohm0.15kW<br>3: 200Ohm0.15kW<br>4: 100Ohm0.15kW<br>5: 100Ohm0.6kW | } <b>A20</b> 1 to 5: This information is used to create a thermal model which determines the maximum permissible power which can be dissipated with the braking resistor. This protects the braking resistance from thermal overload. A thermal overload causes the fault "42:Temp.BrakeRes." |  |
| 2: 300Ohm0.15kW<br>3: 200Ohm0.15kW<br>4: 100Ohm0.15kW<br>5: 100Ohm0.6kW | } <b>A20</b> 1 to 5: This information is used to create a thermal model which determines the maximum permissible power which can be dissipated with the braking resistor. This protects the braking resistance from thermal overload. A thermal overload causes the fault "42:Temp.BrakeRes."   |   |   |  |
| A21   | <p><b>Brake resistor resist.:</b> Only with <b>A20=1</b> (set as desired), resistance value of the braking resistor used<br/>                     Value range in Ω: Depends on type, up to 600</p>  |   |   |  |

<sup>P</sup> Speed depends on pole number **B10**; f<sub>max</sub> = 400 Hz. With a 4-pole motor, this is 12000 rpm at 400 Hz.

• The power pack must be turned off before these parameters can be changed.

*Italics* These parameters are sometimes not shown depending on which parameters are set.





1) See result table in chap. 13.

2) Only available when **D90≠1**

Parameters which are included in the *normal* menu scope (**A10=0**). For other parameters, select **A10=1:extended** or **A10=2:service**.

**E** Parameters marked with a "√" can be parameterized separately from each other in parameter record 1 and 2.

## 11. Parameter Description

| A.. Inverter       |   | E |
|--------------------|---|---|
| Para. No.          | Description   |   |
| A22                | <b>Braking resistor rating:</b> Only with <b>A20=1</b> (set as desired), capacity of the braking resistor used. Entering <b>A22=0</b> kW automatically extends the ramps when DC link voltage is too high (If no braking resistor is connected, the fault "36:Highvoltage" is avoided.).<br><i>Value range in kW: 0 to ..., depends on type</i>   |   |
| A23                | <b>Braking resistor therm.:</b> Only with <b>A20=1</b> (set as desired), thermal time constant of the braking resistor<br><i>Value range in sec: 0.1 to 40 to 100</i>   |   |
| A30•               | <b>Operation input:</b> Specifies the origin of the control signals (i.e., enable, direction of rotation and reference value)<br><i>0: control interface (X1);</i> Control signals (e.g., enable and so on) are generated via the X1 terminals. All binary inputs must be programmed accordingly. Fieldbus operation without <i>Drivocom</i> profile.<br><i>1: serial (X3);</i> Control signals (e.g., enable and so on) are generated from the PC (FDS Tool software). The inverter is connected to the PC via sub D plug connector X3 (RS 232-C interface). See chapter 9.9. Remote control via the PC requires that the enable input (X1.6) be high.<br><i>2: fieldbus;</i> The inverter is put into a <i>Drivocom</i> compatible mode for operation with communication. The device is either controlled exclusively via the bus (the BEs should be set to "0:inactive") or in mixed operation. Signals from the BEs (e.g., halt and limit switch (stop+, stop -) take priority over the fieldbus signals. If the control is performed only via the fieldbus, the input functions (i.e., <b>F25</b> , <b>F31</b> to <b>F35</b> ) must be set to "0:inactive." Control of the drive via fieldbus requires that the enable input (X1.6) be high. |   |
| A31                | <b>Esc-reset:</b> Use the  key on Controlbox to acknowledge faults while they are being indicated.<br><i>0: inactive;</i><br><i>1: active;</i> Faults can be acknowledged with  on Controlbox.  |   |
| A32                | <b>Auto-reset:</b> Faults which occur are acknowledged automatically.<br><i>0: inactive;</i><br><i>1: active;</i> The inverter acknowledges some faults automatically. See chapter 15. Faults can be automatically acknowledged three times within a time period of 15 minutes (default setting). A fourth fault is not acknowledged automatically. Instead, relay 1 opens, and the fault must be acknowledged in some other way (i.e., enable, binary input <b>F31</b> to <b>F35=13</b> , or  key on Controlbox <b>A31</b> ). The time period for automatic acknowledgment can be parameterized from 1 to 255 min in parameter <b>A33</b> .   |   |
| A33                | <b>Time auto-reset:</b> Time period for automatic acknowledgment. See <b>A32</b> .<br><i>Value range in min: 1 to 15 to 255</i>   |   |
| A34                | <b>Auto-start:</b> Before you activate auto-start <b>A34=1</b> , check to determine whether safety requirements permit an automatic restart. Use only permitted when the standards or regulations pertaining to the system or machine are adhered to.<br><i>0: inactive;</i> After power-on, the enable must change from L level to H level to enable the drive (→ message "12:inhibited"). This prevents the motor from starting up unintentionally (i.e., machine safety).<br><i>1: active;</i> When auto-start is active, the drive can start running immediately (if enabled) after the power is turned on.   |   |
| A35                | <b>Low voltage limit:</b> If the inverter is enabled and the DC-link voltage is less than the value set here, the inverter assumes fault "46:low voltage." With three-phase devices, <b>A35</b> should be approximately 85% of the network voltage so that any failures in a phase can be compensated for.<br><i>Value range in V: depends on type</i>  |   |
| A36                | <b>Mains voltage:</b> Maximum voltage provided to the motor by the inverter. Usually the power voltage. Starting at this voltage, the motor runs in the field weakening range. This specification is important for optimum adjustment in control modes "sensorless vector-control" ( <b>B20=1</b> ) and "vector-control" ( <b>B20=2</b> ).<br><i>Value range in V: depends on type</i>  |   |
| A37                | <b>Reset memorized values:</b> The six different following memorized counters <b>E33</b> to <b>E38</b> (e.g., maximum current, maximum temperature and so on) are reset.  |   |
| A40• <sup>1)</sup> | <b>Read parabox:</b> Read parameters from a Controlbox <i>without</i> automatic storage<br><i>0: inactive;</i><br><i>1 to 7: active;</i> For how it works, compare <b>A01</b> .   |   |
| A41                | <b>Select parameter set:</b> Two parameter records are available. These can be selected via the binary inputs or directly via <b>A41</b> . The selected parameter record does not become active until the enable has been removed and after a maximum of 300 msec have passed. Some parameters retain their validity in both parameter record 1 and parameter record 2. Parameters which can be programmed separately in parameter record 2 are indicated by a  between the coordinate and parameter name. See chapter 7.3.1.  |   |

<sup>P</sup> Speed depends on pole number **B10**;  $f_{max} = 400$  Hz. With a 4-pole motor, this is 12000 rpm at 400 Hz.

• The power pack must be turned off before these parameters can be changed.

*Italics* These parameters are sometimes not shown depending on which parameters are set.

1) See result table in chap. 13.

2) Only available when **D90≠1**

Parameters which are included in the *normal* menu scope (**A10=0**). For other parameters, select **A10=1:extended** or **A10=2:service**.

 Parameters marked with a "√" can be parameterized separately from each other in parameter record 1 and 2.

11. Parameter Description

| A.. Inverter      |  | E                |                   |                 |                 |                 |                  |                 |                   |                  |                  |                 |  |  |
|-------------------|--|------------------|-------------------|-----------------|-----------------|-----------------|------------------|-----------------|-------------------|------------------|------------------|-----------------|--|--|
| Para. No.         | Description  |                  |                   |                 |                 |                 |                  |                 |                   |                  |                  |                 |  |  |
| A41<br>Continued  | <p>0: external; The active parameter record is selected via binary inputs BE1 to BE5. At least one of the parameters <b>F31</b> to <b>F35</b> must be set to "1:parameter set-select" in both parameter records. Parameter record 1 is active when a LOW signal is present on BE. Parameter rec. 2 is active when a HIGH signal is present on BE.</p> <p>1: parameter set 1; The inverter uses parameter record 1. External selection is not possible.</p> <p>2: parameter set 2; The inverter uses parameter record 2. External selection is not possible.</p> <p><b>Caution:</b> Parameter <b>A41</b> is only provided for testing purposes. It is not saved with <b>A00</b>=1. Use a BE or the <b>E101</b> parameter (bus access) if you want to switch parameter records during operation.</p>         |                  |                   |                 |                 |                 |                  |                 |                   |                  |                  |                 |  |  |
| A42 <sup>1)</sup> | <p><b>Copy parameter set 1&gt;2:</b> Copies parameter record 1 to parameter record 2. The old values of parameter record 2 are overwritten. The procedure is started when the value changes from 0 to 1.</p> <p>The result is always "0:error free." The new parameter assignment must be stored in non-volatile memory with <b>A00</b>.</p> <p>0: error free;</p>   |                  |                   |                 |                 |                 |                  |                 |                   |                  |                  |                 |  |  |
| A43 <sup>1)</sup> | <p><b>Copy parameter set 2&gt;1:</b> Same as <b>A42</b> except parameter record 2 is copied to parameter record 1</p> <p>0: error free;</p>  |                  |                   |                 |                 |                 |                  |                 |                   |                  |                  |                 |  |  |
| A50               | <p><b>Tip:</b> Permits commissioning with minimum circuiting of the control terminal as long as <b>A51</b> is entered.</p> <p>0: inactive; Normal operation</p> <p>1: active; The controller only requires a high signal on the "enable" input. All other binary control signals have no function when <b>C60</b>&lt;2. The  and  keys on Controlbox can be used to accelerate the drive counter-clockwise or clockwise to the speed set in <b>A51</b>. Since an enable is generated which has a higher priority than the additional enable, operation remains possible even when the additional-enable is low on fieldbus.</p>  |                  |                   |                 |                 |                 |                  |                 |                   |                  |                  |                 |  |  |
| A51               | <p><b>Tip reference value:</b> Reference value for speed for commissioning without external circuiting of the control inputs. The "enable" input must be high! The current actual speed is shown on the right of the display. When <b>A50</b>=1 and <b>A51</b> is in input mode (value flashing), <b>A51</b> becomes active as continuous reference value. For behavior of enable and BEs, see <b>A50</b>.</p> <p>Value range in rpm: -12000<sup>P</sup> ... 300<sup>P</sup> ... 12000<sup>P</sup></p>   | √                |                   |                 |                 |                 |                  |                 |                   |                  |                  |                 |  |  |
| A55               | <p><b>Key hand function:</b> Can be used to disable the MANUAL  key on Controlbox for turning local operation on/off. For additional information, see Controlbox documentation (no. 441 479).</p> <p>0: inactive;  key has no function.</p> <p>1: local;  key activates local operation. Device enabling is then handled exclusively by the keys "green I"  and "red 0" . The  and  keys can be used to move backward and forward in the status display. Active local operation and active enable are indicated by LEDs on Controlbox. The reference speed results from <b>A51</b> for speed mode.</p> <p><b>CAUTION:</b> When local operation is turned off with the  key (LED goes off), the drive immediately switches back to the queued control signals (i.e., danger of unintentional startup!).</p> |                  |                   |                 |                 |                 |                  |                 |                   |                  |                  |                 |  |  |
| A80               | <p><b>Serial address:</b> Only when <b>A10</b>=2. Address for communication via X3 with FDS Tool and with master via USS protocol (see documentation: USS coupling for <b>POSIDRIVE</b>® and <b>POSIDYN</b>®, no. 441564)</p> <p>Value range: 0 to 31</p>  |                  |                   |                 |                 |                 |                  |                 |                   |                  |                  |                 |  |  |
| A82               | <p><b>CAN-baudrate:</b> Sets the baud rate for the Kommubox CAN bus. Cf. CAN bus documentation no. 441 562.</p> <table border="0"> <tr> <td>0: 10 kbit/sec</td> <td>3: 100 kbit/sec</td> <td>6: 500 kbit/sec</td> </tr> <tr> <td>1: 20 kbit/sec</td> <td>4: 125 kbit/sec</td> <td>7: 800 kbit/sec</td> </tr> <tr> <td>2: 50 kbit/sec</td> <td>5: 250 kbit/sec</td> <td>8: 1000 kbit/sec</td> </tr> </table>  | 0: 10 kbit/sec   | 3: 100 kbit/sec   | 6: 500 kbit/sec | 1: 20 kbit/sec  | 4: 125 kbit/sec | 7: 800 kbit/sec  | 2: 50 kbit/sec  | 5: 250 kbit/sec   | 8: 1000 kbit/sec |                  |                 |  |  |
| 0: 10 kbit/sec    | 3: 100 kbit/sec  | 6: 500 kbit/sec  |                   |                 |                 |                 |                  |                 |                   |                  |                  |                 |  |  |
| 1: 20 kbit/sec    | 4: 125 kbit/sec  | 7: 800 kbit/sec  |                   |                 |                 |                 |                  |                 |                   |                  |                  |                 |  |  |
| 2: 50 kbit/sec    | 5: 250 kbit/sec  | 8: 1000 kbit/sec |                   |                 |                 |                 |                  |                 |                   |                  |                  |                 |  |  |
| A83               | <p><b>Busaddress:</b> Specifies the device address for use with the fieldbus (i.e., Kommubox). For permissible value range, see documentation of the applicable Kommubox. <b>A83</b> has no effect on device programming via PC with FDS Tool or via the RS 232 interface with the USS protocol.</p> <p>Value range: 0 to 125</p>  |                  |                   |                 |                 |                 |                  |                 |                   |                  |                  |                 |  |  |
| A84               | <p><b>Profibus baudrate:</b> When the FAS is used with the PROFIBUS-DP Kommubox, the baud rate found on the bus is <i>indicated</i> (!) here. Cf. PROFIBUS-DP documentation no. 441 535.</p> <table border="0"> <tr> <td>0: not found</td> <td>3: 45.45kbit/sec</td> <td>6: 500 kbit/sec</td> <td>9: 6000kbit/sec</td> </tr> <tr> <td>1: 9.6kbit/sec</td> <td>4: 93.75kbit/sec</td> <td>7: 1500kbit/sec</td> <td>10: 12000kbit/sec</td> </tr> <tr> <td>2: 19.2kbit/sec</td> <td>5: 187.5kbit/sec</td> <td>8: 3000kbit/sec</td> <td></td> </tr> </table>  | 0: not found     | 3: 45.45kbit/sec  | 6: 500 kbit/sec | 9: 6000kbit/sec | 1: 9.6kbit/sec  | 4: 93.75kbit/sec | 7: 1500kbit/sec | 10: 12000kbit/sec | 2: 19.2kbit/sec  | 5: 187.5kbit/sec | 8: 3000kbit/sec |  |  |
| 0: not found      | 3: 45.45kbit/sec   | 6: 500 kbit/sec  | 9: 6000kbit/sec   |                 |                 |                 |                  |                 |                   |                  |                  |                 |  |  |
| 1: 9.6kbit/sec    | 4: 93.75kbit/sec   | 7: 1500kbit/sec  | 10: 12000kbit/sec |                 |                 |                 |                  |                 |                   |                  |                  |                 |  |  |
| 2: 19.2kbit/sec   | 5: 187.5kbit/sec   | 8: 3000kbit/sec  |                   |                 |                 |                 |                  |                 |                   |                  |                  |                 |  |  |

<sup>P</sup> Speed depends on pole number **B10**;  $f_{max} = 400$  Hz. With a 4-pole motor, this is 12000 rpm at 400 Hz.

• The power pack must be turned off before these parameters can be changed.

*Italics* These parameters are sometimes not shown depending on which parameters are set.

1) See result table in chap. 13.

2) Only available when **D90**≠1

Parameters which are included in the *normal* menu scope (**A10**=0). For other parameters, select **A10**=1:extended or **A10**=2:service.

Parameters marked with a "√" can be parameterized separately from each other in parameter record 1 and 2.

11. Parameter Description

| <b>B.. Motor</b> |  | <b>E</b> |
|------------------|--|----------|
| Para. No.        | Description  |          |
| <b>B00•</b>      | <p><b>Motor-type:</b> Motor selection from the motor database. The STÖBER system motor used is specified with <b>B00=1</b> to <b>20</b>. <b>B00=0</b> (user defined) is used for special windings or motors of other manufacturers.</p> <p><i>0: user defined;</i> Number of poles, P, I, n, V, f and cos PHI must be specified in <b>B10</b> to <b>B16</b>.</p> <p>It is essential to perform and store <b>B41</b> (auto-tuning). Auto-tuning of the motor determines the winding resistors. This is required for optimum adjustment between inverter and motor.</p> <p>1: 63K Y 0.12kW      6: 71K D 0.25kW      11: 80L Y 0.75kW      16: 90L D 1.5kW<br/>                 2: 63K D 0.12kW      7: 71L Y 0.37kW      12: 80L D 0.75kW      17: 100K Y 2.2kW<br/>                 3: 63M Y 0.18kW      8: 71L D 0.37kW      13: 90S Y 1.1kW      18: 100K D 2.2kW<br/>                 4: 63M D 0.18kW      9: 80K Y 0.55kW      14: 90S D 1.1kW      19: 100L Y 3kW<br/>                 5: 71K Y 0.25kW      10: 80K D 0.55kW      15: 90L Y 1.5kW      20: 100L D 3kW</p> <div style="border: 1px solid black; padding: 5px; margin: 5px 0;">                     All necessary data are stored for these types of motors in a database. This permits optimum adjustment between motor and inverter. Parameters <b>B10</b> to <b>B16</b> are not shown.                 </div> <p>An "***" on the display (Controlbox) means that at least one of the parameters (<b>B53</b>, <b>B64</b> and <b>B65</b>) differs from the default setting of the STÖBER motor database.</p> | √        |
| <b>B10•</b>      | <p><b>Poles:</b> Calculated from the nominal speed of the motor <math>p=2 (f \times 60/n_{Nom})</math>. Internally, the controller works with frequencies. Correct speed indication requires entry of the number of poles.</p> <p><i>Value range:</i> 2 to 4 to 16</p>   | √        |
| <b>B11•</b>      | <p><b>P-nominal:</b> Nominal power as per nameplate</p> <p><i>Value range in kW:</i> 0.12 ... (depends on type)</p>  | √        |
| <b>B12</b>       | <p><b>I-nominal:</b> Nominal current as per nameplate. Remember type of connection (Y/Δ) of the motor must correspond to <b>B14</b>.</p> <p><i>Value range in A:</i> 0 ... (depends on type)</p>   | √        |
| <b>B13</b>       | <p><b>n-nominal:</b> Nominal speed as per nameplate</p> <p><i>Value range in rpm:</i> 0 to (depends on type) to 12000<sup>P</sup> (<sup>P</sup> Depends on pole number <b>B10</b>; <math>f_{max} = 400</math> Hz)</p>  | √        |
| <b>B14•</b>      | <p><b>V-nominal:</b> Nominal voltage as per nameplate. Remember type of connection (Y/Δ) of the motor must correspond to <b>B12</b>.</p> <p><i>Value range in V:</i> 0 to (depends on type) to 480</p>   | √        |
| <b>B15•</b>      | <p><b>f-nominal:</b> Nominal frequency of the motor as per nameplate. The slope of the V/f curve and thus the characteristics of the drive are specified with parameters <b>B14</b> and <b>B15</b>. The V/f curve determines the frequency (<b>F15:</b> f-nominal) at which the motor is operated with the nominal voltage (<b>B14:</b> V-nominal). Voltage and frequency can be increased linearly to more than the nominal point. The upper voltage limit is the power voltage which is present. STÖBER system motors up to model 112 offer the capability of star/delta operation. Operation with 400 V Δ makes it possible to increase power by the factor <math>\sqrt{3}</math> and provide an expanded range with constant torque. With this type of connection, the motor has increased current requirements. The following must be ensured.</p> <ul style="list-style-type: none"> <li>- The frequency inverter is designed for this power (<math>P_{\Delta} = \sqrt{3} \times P_Y</math>).</li> <li>- <b>B12</b> (I-nominal) is parameterized to the appropriate nominal motor current (<math>I_{\Delta Nom} = \sqrt{3} \times I_{Y Nom}</math>).</li> </ul> <p><i>Value range in Hz:</i> 10 to 50 to 330</p>   | √        |
|                  | <p style="text-align: center;"><b>B15 (f-nom.)</b></p> <p style="text-align: center;">Y circuit</p> <div style="display: flex; justify-content: center; gap: 20px;"> <div style="text-align: center;"> <p>U1 V1 W1</p> <p>○ ○ ○</p> <p>● ● ●</p> <p>W2 U2 V2</p> </div> <div style="text-align: center;"> <p>Δ circuit</p> <p>U1 V1 W1</p> <p>● ● ●</p> <p>W2 U2 V2</p> </div> </div> <p style="text-align: center;"><b>Motor circuits</b></p>   | √        |
| <b>B16</b>       | <p><b>cos PHI:</b> The cos Phi of the nameplate of the motor is required for control.</p> <p><i>Value range:</i> 0.5 to (depends on type) to 1</p>   | √        |
| <b>B20•</b>      | <p><b>Control mode:</b> Specifies the type of motor control.</p> <p><i>0: V/f-control;</i> V/f control changes voltage and frequency proportionally to each other so that machine flow remains constant. Utilized, for example, when reluctance motors or several motors are used with one inverter.</p> <p><i>1: sensorless vector-control with 2-track encoder feedback (SLVC);</i> Vector control without feedback. Much better speed accuracy and dynamics. <b>B31</b>, <b>B32</b> and <b>C30</b> can be used to manipulate dynamic reactions.</p> <p><i>2: vector-control feedback;</i> Vector control with feedback. The signals of the speed feedback are evaluated by the inverter via binary inputs BE4/BE5. <b>F34=14</b> and <b>F35=15</b> must be parameterized. For commissioning, see chap. 9.6.</p>   | √        |

<sup>P</sup> Speed depends on pole number **B10**;  $f_{max} = 400$  Hz. With a 4-pole motor, this is 12000 rpm at 400 Hz.

• The power pack must be turned off before these parameters can be changed.

*Italics* These parameters are sometimes not shown depending on which parameters are set.

1) See result table in chap. 13.

2) Only available when **D90≠1**

Parameters which are included in the *normal* menu scope (**A10=0**). For other parameters, select **A10=1:extended** or **A10=2:service**.

**E** Parameters marked with a "√" can be parameterized separately from each other in parameter record 1 and 2.

11. Parameter Description

| <b>B.. Motor</b> |   | <b>E</b> |
|------------------|---|----------|
| Para. No.        | Description   |          |
| B21•             | <b>V/f-characteristic:</b> Effective regardless of the control mode selected in <b>B20</b> .<br><i>0: linear;</i> Voltage/frequency characteristic is linear. Suitable for all applications.<br><i>1: square;</i> Square characteristic for use with fans and pumps   | √        |
| B22              | <b>V/f-gain:</b> Offset factor for the slope of the V/f curve<br>The slope for V/f-gain=100% is specified by V-nom. ( <b>B14</b> ) and f-nom. ( <b>B15</b> ).<br><i>Value range in %:</i> 90 to 100 to 110  | √        |
| B23              | <b>Boost:</b> Only effective when <b>B20=0</b> (V/f-control)<br>Boost means an increase in voltage in the lower speed range which provides more startup torque. With a boost of 100%, nominal motor current begins flowing at 0 Hz. Determination of required boost voltage requires that the stator resistance of the motor be known. If <b>B00=0</b> (user defined), it is essential to perform <b>B41</b> (autotuning).<br>If <b>B00=1</b> to 19, the stator resistance of the motor is specified by the motor selected.<br><i>Value range in %:</i> 0 to 10 to 400  | √        |
| B24•             | <b>Switching frequency:</b> The noise emission of the drive is reduced by changing the switching frequency. However, since increasing the switching frequency also increases loss, permissible nominal motor current ( <b>B12</b> ) must be reduced if the switching frequency is increased.<br>At a switching frequency of 16 kHz and $V_{Mains} = 400$ V, the inverter is able to supply a continuous current of 46% of its nominal current. At 8 kHz, it can supply 75%. <b>For applications starting with 200 Hz, the switching frequency must be set to 8 kHz.</b> The switching frequency is automatically reduced based on the thermal model ( <b>E22</b> ).<br><i>Value range in kHz:</i> 4 to 16 (adjustable in 2 kHz increments)  | √        |
| B25•             | <b>Halt flux:</b> Only if <b>B20≠0</b> . <b>B25</b> specifies whether the motor remains powered during halt and quick stop when the brakes have been applied. After a HALT, the motor remains fully powered for the time <b>B27</b> . Output signal "22:ready for reference value" indicates that the magnetic field is being generated.<br><i>0: inactive;</i> When the brakes are applied ( <i>halt, quick stop</i> ), power is withdrawn from the motor, and the motor is demagnetized. The advantage of this is improvement of thermal motor balance since the motor has time to cool off during the pauses. The disadvantage of this is the increased time required for remagnetization (i.e., rotor time constant, approx. 0.5 sec). The inverter automatically determines how much time is required and adds this to brake release time <b>F06</b> .<br><b>1: active;</b> Default setting. Magnetization current flows through the motor and speeds up reaction to brake release. Disadvantage: The motor heats up, and the magnetization current can be up to 40% of the nominal current depending on the size of the motor.<br><b>2: 75%;</b> Current reduced to 75%. Otherwise same as <b>B25=0</b> .<br><b>3: 50%;</b><br><b>4: 25%;</b> | √        |
| B27              | <b>Time halt flux:</b> When a reduction of halt flux <b>B25</b> occurs, the full magnetization current is still retained for time <b>B27</b> when the brakes are applied and the power pack is active (e.g., HALT signal).<br><i>Value range in sec:</i> 0 to 255   | √        |
| B30              | <b>Addit.motor-operation:</b> Only if <b>B20=0</b> (V/f-control). For multiple-motor operation. Permits an additional motor to be connected to the enabled inverter. Motor voltage is briefly reduced to prevent overcurrent switchoff.<br><i>0: inactive;</i><br><i>1: active;</i>   | √        |
| B31              | <b>Oscillation damping:</b> When idling, large motors may tend to sympathetic vibration. Increasing the parameter <b>B31</b> damps these oscillations when <b>B20=2:SLVC</b> . Values from 60 to 100% are suitable for problematic drives. With <b>B20=2:Vector Control</b> , <b>B31</b> limits the possibility, during generator operation, of using the increase in the rise of DC link voltage to increase magnetization and thus braking torque. This can have a positive effect on smoothness of running when the drive is alternating between motor and generator operation at a constant higher speed.<br><i>Value range in %:</i> 0 to 30 to 100  | √        |
| B32              | <b>SLVC-dynamics:</b> <b>B32</b> can be used to manipulate the speed at which SLVC reacts to changes in load.<br><b>B32=100%</b> means greatest dynamics.<br><i>Value range in %:</i> 0 to 70 to 100  | √        |

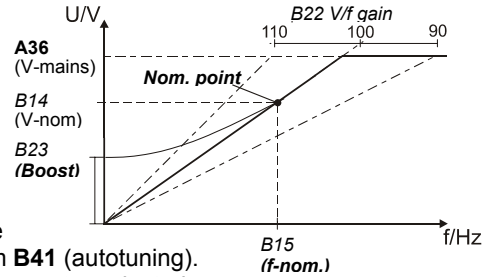

P Speed depends on pole number **B10**;  $f_{max} = 400$  Hz. With a 4-pole motor, this is 12000 rpm at 400 Hz.  
 • The power pack must be turned off before these parameters can be changed.  
*Italics* These parameters are sometimes not shown depending on which parameters are set.  
 1) See result table in chap. 13. 2) Only available when **D90≠1**  
 Parameters which are included in the *normal* menu scope (**A10=0**). For other parameters, select **A10=1:extended** or **A10=2:service**.  
**E** Parameters marked with a "√" can be parameterized separately from each other in parameter record 1 and 2.

11. Parameter Description

| <b>B.. Motor</b>   |  | <b>E</b> |
|--------------------|--|----------|
| Para. No.          | Description  |          |
| B40 <sup>•1)</sup> | <p><b>Phase test:</b><br/>                     0: inactive;<br/>                     1: active; Tests motor symmetry in increments of 60°. The following points are checked.</p> <ul style="list-style-type: none"> <li>- Connection of phases U, V and W</li> <li>- Symmetry of the winding resistances of the phases U, V and W. If a winding resistor deviates by ±10%, the inverter reports "19:symmetry."</li> <li>- Type of connection of the motor. If a STÖBER system motor has been selected with parameter <b>B00</b>=1 to 20, the type of connection of the selected STÖBER system motor (i.e., star/delta) is compared with that of the connected motor. Deviations are reported with "20:motorConnect."</li> </ul> <p><b>The function is started when the level on the input enable (X1.6) changes from low to high.</b> Exiting the parameter requires another low signal on the enable.</p> |          |
| B41 <sup>•1)</sup> | <p><b>Autotuning:</b><br/>                     0: inactive;<br/>                     1: active; Stator resistance <b>B53</b> is measured. The function is started when the level on the input enable (X1.6) changes from low to high. Exiting the parameter requires another low signal on the enable. <b>A00</b>=1 is used to save the measuring results in non-volatile memory.<br/> <b>B00</b>=0, Be sure to autotune motor. Important for optimum adjustment of inverter and motor.<br/> <b>B00</b>=1 to 20; Autotuning of the motor is not required.</p>  |          |
| B53                | <p><b>R1-motor:</b> Stator resistance of the motor winding, <math>R1=R_{u-v}/2</math>. Usually only entered for non STÖBER motors or autotuning with <b>B41</b>. In the Y circuit, <b>B53</b> directly corresponds to the branch resistance. In the Δ circuit, 1/3 of the branch resistance must be entered. With STÖBER motors, <b>B53</b> should usually not be changed. Value is adjusted with <b>B41</b> (autotuning). An "*" indicates deviation from the STÖBER motor database.<br/>                     Value range in Ω: 0.01 to depends on type to 327.67</p>   | √        |
| B64                | <p><b>Ki-IQ (moment):</b> Only when <b>B20</b>=2. Integral gain of the torque controller.<br/>                     Value range in %: 0 to depends on type to 400</p>   | √        |
| B65                | <p><b>Kp-IQ (moment):</b> Only when <b>B20</b>=2. Proportional gain of the torque controller.<br/>                     Value range in %: 0 to depends on type to 400</p>   | √        |
| <b>C.. Machine</b> |  | <b>E</b> |
| Para. No.          | Description  |          |
| C00                | <p><b>n-Min:</b> Minimum permissible speed. The speed is related to the motor shaft speed. Reference values less than n-Min are ignored and raised to n-Min.<br/>                     Value range in rpm: 0 to <b>C01</b></p>  | √        |
| C01                | <p><b>n-Max:</b> Maximum permissible speed. The speed is related to the motor shaft speed. Reference values over n-Max are ignored and limited to n-Max.<br/>                     Value range in rpm: <b>C00</b> to 3000<sup>P</sup> to 12000<sup>P</sup> (P = depends on poles <b>B10</b>; f<sub>max</sub> = 400 Hz)</p>  | √        |
| C02 <sup>•</sup>   | <p><b>Perm. direction of rotat.:</b> Determines the permissible direction of rotation. The direction of rotation can be specified via the binary inputs.<br/>                     0: clockwise &amp; counter-clockwise;<br/>                     1: clockwise;<br/>                     2: counter-clockwise;</p>  | √        |
| C03                | <p><b>M-Max 1:</b> Maximum torque in % of nominal motor torque. The active torque limit can be further reduced with an analog input (see <b>F25</b>=2). If the maximum torque is exceeded, the controller responds with the message "47:drive overload." See also remarks for <b>C04</b>.<br/>                     Value range in %: 0 to 150 to 400%* * Value is limited by the maximum inverter current.</p>   | √        |
| C04                | <p><b>M-Max 2:</b> Additional torque limit. You can switch between <b>C03</b> and <b>C04</b> with a binary input (<b>F3..=10:torque select</b>) or automatically when startup mode = cycle characteristic (<b>C20</b>=2). See chap. 9.2.<br/> <b>Remarks:</b> Since <b>C04</b> is always active for a quick stop, <b>C04</b> ≥ <b>C03</b> should usually apply!<br/>                     Value range in %: 0 to 150 to 400* * Value is limited by the maximum inverter current.</p>  | √        |
| C10                | <p><b>Skip speed 1:</b> Prevents prolonged use of a drive in the resonance range. The drive goes through the entered speeds and a tolerance of ±0.4 Hz with the decel-quick ramp (<b>D81</b>). The four "skip speeds" can be placed next to each other.<br/>                     Value range in rpm: 0 to 12000<sup>P</sup> (P depends on poles <b>B10</b>; f<sub>max</sub> = 400 Hz)</p>  | √        |
| C11                | <p><b>Skip speed 2:</b> See <b>C10</b>.<br/>                     Value range in rpm: 0 to 12000<sup>P</sup></p>  | √        |
| C12                | <p><b>Skip speed 3:</b> See <b>C10</b>.<br/>                     Value range in rpm: 0 to 12000<sup>P</sup></p>  | √        |

<sup>P</sup> Speed depends on pole number **B10**; f<sub>max</sub> = 400 Hz. With a 4-pole motor, this is 12000 rpm at 400 Hz.

• The power pack must be turned off before these parameters can be changed.

*Italics* These parameters are sometimes not shown depending on which parameters are set.

1) See result table in chap. 13. 2) Only available when **D90**≠1

Parameters which are included in the *normal* menu scope (**A10**=0). For other parameters, select **A10**=1:extended or **A10**=2:service.

**E** Parameters marked with a "√" can be parameterized separately from each other in parameter record 1 and 2.

11. Parameter Description

| <b>C.. Machine</b> |   | <b>E</b> |
|--------------------|---|----------|
| Para. No.          | Description   |          |
| C13                | <b>Skip speed 4:</b> See C10.<br>Value range in rpm: 0 to 12000 <sup>P</sup>  | √        |
| C20•               | <b>Startup mode:</b> Determines the startup behavior of the drive<br><i>0: standard;</i> Default setting. Not dependent on control mode (B20).<br>1: <i>load start;</i> Only if B20=1 (sensorless VC). For machines with increased breakaway torque. The motor torque is increased to M-load start (C21) during the time t-load start (C22). After expiration of this time, the inverter uses the standard ramp again.<br>2: <i>cycle characteristic;</i> Effectivity not dependent on the control mode (B20)<br>- Automatic switch between the specified torque limits M-Max 1 (C03) and M-Max 2 (C04). M-Max 1 applies during constant travel. M-Max 2 applies during the acceleration phase.<br>- If B20=1 (sensorless vector control), a torque precontrol procedure is performed (i.e., the inverter calculates the required torque from the motor type specified (B00) and the ratio of load/motor inertia (C30). This calculated torque is then given to the drive.<br>3: <i>capturing;</i> Only if B20=1. A rotating motor is connected to the inverter. The inverter determines the actual speed of the motor, synchronizes itself, and specifies the appropriate reference value. | √        |
| C21                | <b>M-load start:</b> Only if C20=1 (load start). Specification of the torque for the load start.<br>Value range in %: 0 to 100 to 400   | √        |
| C22                | <b>t-load start:</b> Only if C20=1. Time for the load start with the torque defined in C21.<br>Value range in sec: 0 to 5 to 9.9  | √        |
| C30                | <b>J-mach/J-motor:</b> Ratio of the inertia of load to motor. This factor is effective for all control modes and is important for optimization between inverter and motor (i.e., dynamics). Entry is not mandatory.<br>Value range: 0 to 1000   | √        |
| C31                | <b>n-controller Kp:</b> Only if B20=2 (vector control with feedback).<br>Proportional gain of the speed controller.<br>Value range in %: 0 to 60 to 400   | √        |
|                    |   |          |
| C32                | <b>n-controller Ki:</b> Only if B20=2. Integral gain of the speed controller. Reduce C32 when overswinging occurs in the target position.<br>Value range in %: 0 to 30 to 400   | √        |
| C35                | <b>n-control. Kp standstill:</b><br>C31 and C32 are multiplied by C35 as soon as the motor speed drops below C40.<br>Value range in %: 5 to 100   | √        |
| C40                | <b>n-window:</b> If F00=3 (relay 2 as signal relay for "3:reference value-reached") or F00=2 (relay 2 as signal contact for speed "2:standstill"), the reference value is considered reached in a window of reference value ±C40.<br>A halting brake is not activated as long as [n] > C40.<br>Value range in rpm: 0 to 30 to 300 <sup>P</sup>  | √        |
| C41                | <b>Operating range n-Min:</b> Parameters C41 to C46 can be used to specify an operating area. An output (F00=6) can be used to signal that these values have been exceeded. All area monitoring procedures are performed at the same time. If area monitoring is not required, the minimum parameters must be set to the lower-limit values, and the maximum parameters must be set to the upper-limit values. Cf. chapter 9.3. When C49=0, operating-range monitoring is suppressed when the motor is not powered and during acceleration/braking procedures. When C48=1, amount generation is activated.<br>Value range in rpm: 0 to C42  | √        |
| C42                | <b>Operating range n-Max:</b> See C41.<br>Value range in rpm: C41 to 6000 <sup>P</sup> to 12000 <sup>P</sup> ( <sup>P</sup> depends on poles B10; f <sub>max</sub> = 400 Hz)  | √        |
| C43                | <b>Operating range M-Min:</b> See C41.<br>Value range in %: 0 to C44  | √        |
| C44                | <b>Operating range M-Max:</b> See C41.<br>Value range in %: C43 to 400  | √        |
| C45                | <b>Operating range X-Min.:</b> See C41. Monitors value defined in C47.<br>Value range in %: -400 to 0 to C46  | √        |
| C46                | <b>Operating range X-Max.:</b> See C41. Monitors value defined in C47.<br>Value range in %: C45 to 400  | √        |

<sup>P</sup> Speed depends on pole number B10; f<sub>max</sub> = 400 Hz. With a 4-pole motor, this is 12000 rpm at 400 Hz.

• The power pack must be turned off before these parameters can be changed.

*Italics* These parameters are sometimes not shown depending on which parameters are set.

1) See result table in chap. 13.

2) Only available when D90≠1

Parameters which are included in the *normal* menu scope (A10=0). For other parameters, select A10=1:extended or A10=2:service.

**E** Parameters marked with a "√" can be parameterized separately from each other in parameter record 1 and 2.

11. Parameter Description

| <b>C.. Machine</b>         |   | <b>E</b> |
|----------------------------|---|----------|
| Para. No.                  | Description   |          |
| C47                        | <p><b>Operating range C45/C46:</b> Defines the range to be monitored.</p> <p><i>Q:</i> E01 P-motor; 5: E22 i2t-device; 8: E62 actual M-Max;<br/>                     1: E02 M-motor; 6: E23 i2t-motor; 10: E71 AE1-scaled;<br/>                     2: E10 AE1-level; 7: E24 i2t-braking resistor; 13: E14 BE5-frequency RV<br/>                     14: E08 n-motor (% ref. to C01)</p>  | √        |
| C48                        | <p><b>Operating range of amount C47:</b><br/> <i>Q:</i> absolute; First, the amount is generated from the signal selected in C47.<br/>                     Example: C47=AE1; C45=30%; C46=80%. The operating range is -80% to -30% and +30% to +80%.<br/> <i>1:</i> range; The signal selected in C47 must be located in range C45 to C46.<br/>                     Example: C47=AE1, C45= -30%, C46= +10%. The operating range is -30% to +10%.</p>  | √        |
| C49                        | <p><b>Operating range accel&amp;ena:</b><br/> <i>Q:</i> inactive; During acceleration or deactivated enable, the "operating range" signal for the binary outputs is set to "0"=ok. The three ranges are only monitored during stationary operation (compatible with device software V 4.3).<br/> <i>1:</i> active; The operating range is always monitored.</p>   | √        |
| C50                        | <p><b>Display function:</b> Parameters C50 to C53 can be used to design the first line of the display as desired. See chapter 7.3.1. Eight characters are available for a number, and 8 characters are available for any unit. Display value = raw value/display factor.</p> <p><i>Q:</i> n2 &amp; I-motor;<br/>                     1: E00 I-motor; The inverter supplies the actual motor current in amperes as the raw value.<br/>                     2: E01 P-motor %; The inverter supplies as the raw value the actual active power as a percentage of the nominal motor power.<br/>                     3: E02 M-motor %; As the raw value, the inverter supplies the actual motor torque as a percentage of the nominal motor torque.<br/>                     4: E08 n-motor; The inverter supplies the actual speed in rpm as the raw value. If V/f control (B20=0) and sensorless vector control (B20=1), the frequency (i.e., motor speed) output by the inverter is indicated. Only with vector control with feedback (B20=2) is the real actual speed indicated.</p> | √        |
| C51                        | <p><b>Display factor:</b> Raw value (C50) is divided by the value entered here.<br/>                     Value range: -1000 to 1 to 1000</p>  | √        |
| C52                        | <p><b>Display decimals:</b> Number of positions after the decimal point for the value in the display.<br/>                     Value range: 0 to 5</p>  | √        |
| C53                        | <p><b>Display text:</b> Only if C50&gt;0. Text for customer-specific unit of measure in the operating display (e.g., "units/hour"). Maximum of 8 positions. Can only be entered with FDS Tool.</p>  | √        |
| C60•                       | <p><b>Run mode</b><br/>                     1: speed; Reference value for speed, conventional operating mode.</p>   | √        |
| <b>D.. Reference Value</b> |   | <b>E</b> |
| Para. No.                  | Description   |          |
| D00                        | <p><b>Reference value accel:</b> Acceleration ramp for the analog reference value input. Is only used for specification of reference value via terminal strip X1 and motor potentiometer.<br/>                     - Voltage via analog input 1 (X1.2 – X1.4)<br/>                     - Frequency via binary input BE5 (X1.5 – X1.11)<br/>                     - Motor potentiometer via the binary inputs (D90=1)<br/>                     Value range in sec/150 Hz * D98: 0 to 3 to 3000</p>  | √        |
| D01                        | <p><b>Reference value decel:</b> Deceleration ramp for the analog reference value input. Is only used for specification of reference value via terminal strip X1 and motor potentiometer.<br/>                     - Voltage via analog input 1 (X1.2 – X1.4)<br/>                     - Frequency via binary input BE5 (X1.5 – X1.11)<br/>                     - Motor potentiometer via the binary inputs (D90=1)<br/>                     Value range in sec/150 Hz * D98: 0 to 3 to 3000</p>  | √        |
| D02 <sup>2)</sup>          | <p><b>Speed (max. ref. value):</b> Parameters D02 to D05 can be used to specify as desired the relationship between analog reference value and speed with a reference value characteristic curve.<br/>                     D02: Speed achieved with the maximum reference value (D03). With C01&lt;D02, "7:n&gt;nmax" is indicated when C01 is exceeded.<br/>                     Value range in rpm: 0 to 3000<sup>P</sup> to 12000<sup>P</sup> (P Depends on pole number B10; f<sub>max</sub> = 400 Hz)</p>   | √        |

<sup>P</sup> Speed depends on pole number B10; f<sub>max</sub> = 400 Hz. With a 4-pole motor, this is 12000 rpm at 400 Hz.  
 • The power pack must be turned off before these parameters can be changed.  
*Italics* These parameters are sometimes not shown depending on which parameters are set.  
 1) See result table in chap. 13. 2) Only available when D90≠1  
 Parameters which are included in the normal menu scope (A10=0). For other parameters, select A10=1:extended or A10=2:service.  
**E** Parameters marked with a "√" can be parameterized separately from each other in parameter record 1 and 2.



11. Parameter Description

| D.. Reference Value |  | E |
|---------------------|--|---|
| Para. No.           | Description  |   |
| D03 <sup>2)</sup>   | <b>Reference value-Max.:</b> Reference value to which the speed (max. RV) (D02) is assigned. Percentage of the analog reference value (10 V=100%) at which the maximum speed (D02) is achieved.<br><i>Value range in %:</i> D05 to 100   | √ |
| D04 <sup>2)</sup>   | <b>Speed (min. ref. value):</b> Speed achieved with minimum reference value (D05).<br><i>Value range in rpm:</i> 0 to 12000 <sup>P</sup> ( <sup>P</sup> Depends on pole number B10; f <sub>max</sub> = 400 Hz)   | √ |
| D05 <sup>2)</sup>   | <b>Reference value-Min.:</b> Reference value to which the speed (min. RV) (D04) is assigned. Percentage of the analog reference value (10 V=100%) at which the minimum speed (D04) is achieved.<br><i>Value range in %:</i> 0 to D03   | √ |
| D06 <sup>2)</sup>   | <b>Reference value offset:</b> Correct an offset on analog input 1 (X1.2 to 4). When the ref. value is 0, the motor may not be permitted to rotate. If a revolution occurs anyway, this value must be entered with reversed sign as the offset (e.g., if param. E10 shows 1.3%, D06 must be parameterized to -1.3%). The value range is ±100%. While the ref. value offset is being entered, the current value of the analog input is shown at the same time (only when Controlbox is connected).<br><i>Value range in %:</i> -100 to 0 to 100   | √ |
| D07 <sup>2)</sup>   | <b>Reference value enable:</b> When the minimum reference value (D05) is set to a value greater than 1%, an enable can be derived from the reference value output.<br><i>Q:</i> inactive;<br><i>1:</i> active; An additional enable is derived from the reference value on analog input 1. If the reference value enable is high, the output is greater than or equal to the minimum reference value (D05). If the reference value enable is low, the output is less than the minimum reference value (D05).   | √ |
| D08 <sup>2)</sup>   | <b>Monitor reference value:</b> Monitors reference value output. Monitors for wire break. Ref. value monitoring will only function if the minimum reference value specified in D05 is greater than or equal to 5% (D05 ≥ 5%).<br><i>Q:</i> inactive;<br><i>1:</i> active; If the reference value output is 5% less than the minimum permissible reference value (D05), the inverter shows "43:RV wire brk."  | √ |
| D09 <sup>2)</sup>   | <b>Fix reference value no.:</b> Selection of a fixed reference value<br><i>Q:</i> external selection via binary inputs and BE functions RV-select 0 to 2<br><i>1 to 7:</i> fixed selection of fixed reference value. BE inputs are ignored.  | √ |
| D10 <sup>2)</sup>   | <b>Accel 1:</b> Up to 7 fixed reference values/ramp records can be defined per parameter record. Selection is made via the binary inputs. At least one binary input must be programmed to reference value selector (e.g., F31=1:RV-select0). The reference value selector is used to assign the fixed reference values or ramp records to the signals of the binary inputs. The result of the binary coding is shown in E60 (0 to 7). The ramp records accel 1 to 7 / decel 1 to 7) are only active in connection with the assigned fixed reference values 1 to 7.<br>Accel 1: Acceleration time for ramp record 1 as related to 150 Hz.<br><i>Value range in sec/150 Hz * D98:</i> 0 to 6 to 3000 | √ |
| D11 <sup>2)</sup>   | <b>Decel 1:</b> Deceleration time for ramp record 1 as related to 150 Hz.<br><i>Value range in sec/150 Hz * D98:</i> 0 to 6 to 3000  | √ |
| D12 <sup>2)</sup>   | <b>Fix reference value 1:</b> Selection is made parallel to ramp record 1 (accel 1/decel 1) via the binary inputs.<br><i>Value range in rpm:</i> -12000 <sup>P</sup> to 750 <sup>P</sup> to 12000 <sup>P</sup>   | √ |
| D20 <sup>2)</sup>   | <b>Accel 2:</b> Acceleration time for ramp rec. 2 as related to 150 Hz<br><i>Value range in sec/150 Hz * D98:</i> 0 to 9 to 3000   | √ |
| D21 <sup>2)</sup>   | <b>Decel 2:</b> Deceleration time for ramp rec. 2 as related to 150 Hz<br><i>Value range in sec/150 Hz * D98:</i> 0 to 9 to 3000   | √ |
| D22 <sup>2)</sup>   | <b>Fix reference value 2:</b> Selection is made parallel to ramp record 2 (accel 2/decel 2) via the binary inputs<br><i>Value range in rpm:</i> -12000 <sup>P</sup> to 1500 to 12000 <sup>P</sup>  | √ |
| D30 <sup>2)</sup>   | <b>Accel 3:</b> Acceleration time for ramp rec. 3 as related to 150 Hz<br><i>Value range in sec/150 Hz * D98:</i> 0 to 12 to 3000  | √ |
| D31 <sup>2)</sup>   | <b>Decel 3:</b> Deceleration time for ramp rec. 3 as related to 150 Hz<br><i>Value range in sec/150 Hz * D98:</i> 0 to 12 to 3000  | √ |
| D32 <sup>2)</sup>   | <b>Fix reference value 3:</b> See D12.<br><i>Value range in rpm:</i> -12000 <sup>P</sup> to 3000 <sup>P</sup> to 12000 <sup>P</sup>  | √ |
| D40 <sup>2)</sup>   | <b>Accel 4:</b> Acceleration time for ramp record 4 as related to 150 Hz<br><i>Value range in sec/150 Hz * D98:</i> 0 to 0.5 to 3000   | √ |
| D41 <sup>2)</sup>   | <b>Decel 4:</b> Deceleration time for ramp record 4 as related to 150 Hz<br><i>Value range in sec/150 Hz * D98:</i> 0 to 0.5 to 3000   | √ |
| D42 <sup>2)</sup>   | <b>Fix reference value 4:</b> See D12.<br><i>Value range in rpm:</i> -12000 <sup>P</sup> to 500 <sup>P</sup> to 12000 <sup>P</sup>   | √ |

| No. | Accel | Decel | Reference Value  |
|-----|-------|-------|------------------|
| 0   | D00   | D01   | Analog, freq,... |
| 1   | D10   | D11   | Fixed RV 1       |
| 2   | D20   | D21   | Fixed RV 2       |
| ⋮   | ⋮     | ⋮     | ⋮                |
| 7   | D70   | D71   | Fixed RV 7       |

<sup>P</sup> Speed depends on pole number B10; f<sub>max</sub> = 400 Hz. With a 4-pole motor, this is 12000 rpm at 400 Hz.

• The power pack must be turned off before these parameters can be changed.

*Italics* These parameters are sometimes not shown depending on which parameters are set.

1) See result table in chap. 13.

2) Only available when D90≠1

Parameters which are included in the *normal* menu scope (A10=0). For other parameters, select A10=1:extended or A10=2:service.

E Parameters marked with a "√" can be parameterized separately from each other in parameter record 1 and 2.

11. Parameter Description

| D.. Reference Value |   | E  |     |     |                        |   |   |          |   |   |        |   |   |         |   |   |   |
|---------------------|---|--|-----|-----|------------------------|---|---|----------|---|---|--------|---|---|---------|---|---|---|
| Para. No.           | Description   |  |     |     |                        |   |   |          |   |   |        |   |   |         |   |   |   |
| D50 <sup>2)</sup>   | <b>Accel 5:</b> Acceleration time for ramp record 5 as related to 150 Hz<br><i>Value range in sec/150 Hz * D98:</i> 0 to <u>1</u> to 3000   | √  |     |     |                        |   |   |          |   |   |        |   |   |         |   |   |   |
| D51 <sup>2)</sup>   | <b>Decel 5:</b> Deceleration time for ramp record 5 as related to 150 Hz<br><i>Value range in sec/150 Hz * D98:</i> 0 to <u>1</u> to 3000   | √  |     |     |                        |   |   |          |   |   |        |   |   |         |   |   |   |
| D52 <sup>2)</sup>   | <b>Fix reference value 5:</b> See <b>D12</b> .<br><i>Value range in rpm:</i> -12000 <sup>P</sup> to <u>1000</u> <sup>P</sup> to 12000 <sup>P</sup>  | √  |     |     |                        |   |   |          |   |   |        |   |   |         |   |   |   |
| D60 <sup>2)</sup>   | <b>Accel 6:</b> Acceleration time for ramp record 6 as related to 150 Hz<br><i>Value range in sec/150 Hz * D98:</i> 0 to <u>2</u> to 3000   | √  |     |     |                        |   |   |          |   |   |        |   |   |         |   |   |   |
| D61 <sup>2)</sup>   | <b>Decel 6:</b> Deceleration time for ramp record 6 as related to 150 Hz<br><i>Value range in sec/150 Hz * D98:</i> 0 to <u>2</u> to 3000   | √  |     |     |                        |   |   |          |   |   |        |   |   |         |   |   |   |
| D62 <sup>2)</sup>   | <b>Fix reference value 6:</b> See <b>D12</b> .<br><i>Value range in rpm:</i> -12000 <sup>P</sup> to <u>2000</u> <sup>P</sup> to 12000 <sup>P</sup>  | √  |     |     |                        |   |   |          |   |   |        |   |   |         |   |   |   |
| D70 <sup>2)</sup>   | <b>Accel 7:</b> Acceleration time for ramp record 7 as related to 150 Hz<br><i>Value range in sec/150 Hz * D98:</i> 0 to <u>2.5</u> to 3000   | √  |     |     |                        |   |   |          |   |   |        |   |   |         |   |   |   |
| D71 <sup>2)</sup>   | <b>Decel 7:</b> Deceleration time for ramp record 7 as related to 150 Hz<br><i>Value range in sec/150 Hz * D98:</i> 0 to <u>2.5</u> to 3000   | √  |     |     |                        |   |   |          |   |   |        |   |   |         |   |   |   |
| D72 <sup>2)</sup>   | <b>Fix reference value 7:</b> See <b>D12</b> .<br><i>Value range in rpm:</i> -12000 <sup>P</sup> to <u>2500</u> <sup>P</sup> to 12000 <sup>P</sup>  | √  |     |     |                        |   |   |          |   |   |        |   |   |         |   |   |   |
| D80                 | <b>Ramp shape:</b><br><i>0:</i> linear;<br><i>1:</i> 'S' ramp; Smoother acceleration/deceleration   | √  |     |     |                        |   |   |          |   |   |        |   |   |         |   |   |   |
| D81                 | <b>Decel-quick:</b> Quick stop ramp. Takes effect when a binary input is programmed to quick stop ( <b>F3.. = 9</b> ) or parameter <b>F38</b> >0. When a quick stop is triggered by the binary inputs, the drive is decelerated with the deceleration ramp set here.<br><i>Value range in sec/150 Hz * D98:</i> 0 to <u>0.2</u> to 3000   | √  |     |     |                        |   |   |          |   |   |        |   |   |         |   |   |   |
| D90•                | <b>Reference value source:</b> See block circuit diagram in chap. 16.<br><i>0:</i> <b>standard reference value;</b><br><i>1:</i> <b>motor potentiometer;</b> Two binary inputs can be used to simulate a "motor potentiometer." This requires that one binary input be programmed to "4: motorpoti up" and another binary input to "5: motorpoti dwn" (e.g., <b>F34=4</b> and <b>F35=5</b> ). Only ramps <b>D00</b> and <b>D01</b> can change the speed.<br><i>2:</i> <b>motor potentiometer+reference value;</b> The reference value for speed of the motor potentiometer function is added to the "standard" reference value (i.e., analog input, fixed reference values). When <b>D90=1</b> , only the motor potentiometer reference value is used. The ramps selected with the binary inputs are used, and the motor potentiometer reference value changes with RV-accel/RV-decel (i.e., <b>D00</b> and <b>D01</b> ). | <table border="1"> <thead> <tr> <th>BE4</th> <th>BE5</th> <th>Motor poti. ref. value</th> </tr> </thead> <tbody> <tr> <td>L</td> <td>L</td> <td>Constant</td> </tr> <tr> <td>H</td> <td>L</td> <td>Larger</td> </tr> <tr> <td>L</td> <td>H</td> <td>Smaller</td> </tr> <tr> <td>H</td> <td>H</td> <td>0</td> </tr> </tbody> </table> | BE4 | BE5 | Motor poti. ref. value | L | L | Constant | H | L | Larger | L | H | Smaller | H | H | 0 |
| BE4                 | BE5   | Motor poti. ref. value   |     |     |                        |   |   |          |   |   |        |   |   |         |   |   |   |
| L                   | L   | Constant   |     |     |                        |   |   |          |   |   |        |   |   |         |   |   |   |
| H                   | L   | Larger   |     |     |                        |   |   |          |   |   |        |   |   |         |   |   |   |
| L                   | H   | Smaller  |     |     |                        |   |   |          |   |   |        |   |   |         |   |   |   |
| H                   | H   | 0  |     |     |                        |   |   |          |   |   |        |   |   |         |   |   |   |
| D91                 | <b>Motorpoti function:</b> Only if <b>D90</b> ≠0 (reference value source≠standard RV)<br><i>0:</i> <b>non-volatile;</b> The reference value which was approached is retained both when the enable is removed and when the power is turned off/on.<br><i>1:</i> <b>volatile;</b> The reference value is set to 0 when the enable becomes low or the power for the drive is turned off.   | √  |     |     |                        |   |   |          |   |   |        |   |   |         |   |   |   |
| D92                 | <b>Negate reference value:</b> See block circuit diagram in chap. 16.<br><i>0:</i> <b>inactive;</b><br><i>1:</i> <b>active;</b> The reference value channel is negated. Corresponds to a reverse in direction of rotation. Not related to the selected reference value.   | √  |     |     |                        |   |   |          |   |   |        |   |   |         |   |   |   |
| D93                 | <b>RV-generator:</b> For commissioning and optimizing the speed controller<br><i>0:</i> <b>inactive;</b> Normal reference value selection<br><i>1:</i> <b>active;</b> ± <b>A51</b> is specified cyclically as reference value. The time can be set in <b>D94</b> .  |  |     |     |                        |   |   |          |   |   |        |   |   |         |   |   |   |
| D94                 | <b>Ref. val. generator time:</b> After this period of time, the sign of the reference value changes when <b>D93=1:active</b> .<br><i>Value range in msec:</i> 0 to <u>500</u> to 32767  | √  |     |     |                        |   |   |          |   |   |        |   |   |         |   |   |   |
| D98                 | <b>Ramp factor:</b> If <b>D98</b> <0 and speed mode ( <b>C60=1</b> ), all ramps (e.g., <b>D00</b> ) are shortened by one or two powers of ten. This makes very sensitive setting of short ramps possible.<br>-2: *0.01 All ramp times shortened by factor of 100.<br>-1: *0.1 All ramp times shortened by factor of 10.<br><i>0:</i> *1 Factory setting. Ramps unchanged.   | √  |     |     |                        |   |   |          |   |   |        |   |   |         |   |   |   |

<sup>P</sup> Speed depends on pole number **B10**; f<sub>max</sub> = 400 Hz. With a 4-pole motor, this is 12000 rpm at 400 Hz.

• The power pack must be turned off before these parameters can be changed.

*Italics* These parameters are sometimes not shown depending on which parameters are set.

1) See result table in chap. 13.

2) Only available when **D90**≠1

Parameters which are included in the *normal* menu scope (**A10=0**). For other parameters, select **A10=1:extended** or **A10=2:service**.

**E** Parameters marked with a "√" can be parameterized separately from each other in parameter record 1 and 2.

11. Parameter Description

| <b>E.. Display Values</b> |   | <b>E</b> |
|---------------------------|---|----------|
| <i>Para. No.</i>          | <i>Description</i>  |          |
| E00                       | <b>I-motor:</b> Indicates the current motor current in amperes  |          |
| E01                       | <b>P-motor:</b> Indicates the current power of the motor in kW and as a relative percentage in relation to nominal motor power  |          |
| E02                       | <b>M-motor:</b> Indicates the current motor torque in Nm and as a relative percentage in relation to nominal motor torque (only on display of Controlbox).  |          |
| E03                       | <b>DC-link-voltage:</b> Indicates the current DC-link voltage<br>Value range for single-phase inverters: 0 to 500 V<br>Value range for three-phase inverters: 0 to 800 V  |          |
| E04                       | <b>V-motor:</b> Indicates the current motor voltage<br>Value range for single-phase inverters: 0 to 230 V<br>Value range for three-phase inverters: 0 to 480 V  |          |
| E05                       | <b>f1-motor:</b> Indicates the current motor frequency in Hz  |          |
| E06                       | <b>n-reference value:</b> Only if <b>C60</b> =1 (speed). Indicates the current ref. val. for speed in relation to the motor shaft.  |          |
| E07                       | <b>n-post-ramp:</b> Indicates the current speed in relation to the motor shaft after the ramp generator   |          |
| E08                       | <b>n-motor:</b> Indicates the current motor speed   |          |
| E09                       | <b>Rotor position:</b> Only if <b>B20</b> =2: <i>vect.feedback</i> . Accumulates the increments of the motor encoder. Digits in front of the decimal point indicate whole revolutions. The three positions after the decimal point are fractions of one motor revolution. This position is available in all run modes.                            |          |
| E10                       | <b>AE1-level:</b> Level of the signal present on analog input (AE) 1 (X1.2 to 4). ±10 V is 100%.  |          |
| E12                       | <b>ENA-BE1-BE2-level:</b> Level of the enable inputs (X1.6), binary input 1 (X1.7) and binary input 2 (X1.8). Low level is represented by 0, and high level is represented by 1.  |          |
| E13                       | <b>BE3-BE4-BE5-level:</b> Level of binary inputs 3, 4 and 5 (X1.9 to X1.11). Low level is represented by 0, and high level is represented by 1.   |          |
| E14                       | <b>BE5-frequence ref. value:</b> If binary input 5 is parameterized to frequency reference value specification ( <b>F35</b> =14), reference value output can be monitored here. 0% corresponds to a frequency specification of 100 Hz on BE5. 100% corresponds to the maximum permissible frequency reference value as entered under <b>F37</b> . |          |
| E15                       | <b>n-encoder:</b> If speed feedback is connected to BE4 and BE5 and BE5 is not parameterized to the frequency reference value, the actual encoder speed can be monitored here. The display is not related to the control mode set under <b>B20</b> .  |          |
| E17                       | <b>Relay 1:</b> Status of relay 1 (ready for operation)<br>0: open; For meaning, see parameter <b>F10</b> .<br>1: closed; Ready for operation   |          |
| E18                       | <b>Relay 2:</b> Status of relay 2. The function of relay 2 is specified with parameter <b>F00</b> .<br>0: open;<br>1: closed;   |          |
| E19                       | <b>BE15...BE1 &amp; enable:</b> The status of the binary inputs including ASi-KommuBox is shown as a binary word.   |          |
| E20                       | <b>Device utilization:</b> Indicates the current load of the inverter in %. 100% corresponds to the nominal capacity of the inverter.   |          |
| E21                       | <b>Motor utilization:</b> Indicates the current load of the motor in %. Reference value is the nominal motor current specified under <b>B12</b> .   |          |
| E22                       | <b>i2t-device:</b> Level of the thermal device model (i.e., i2t model). If utilization is 100%, the fault message "39:tempDev.i2t" appears.   |          |
| E23                       | <b>i2t-motor:</b> Level of the thermal motor model (i.e., i2t model). 100% corresponds to full load. The thermal model is based on the data specified under group <b>B</b> (motor) (e.g., continuous operation (S1 operation)).   |          |
| E24                       | <b>i2t-braking resistor:</b> Level of the thermal braking resistor model (i.e., i2t model). 100% corresponds to full load. The data of the braking resistor are specified with <b>A20</b> to <b>A23</b> .   |          |
| E25                       | <b>Temperature device:</b> Current device temperature in °C. Is set to +25 °C when the FAS is powered by a 24 V LC option board when the power (230 V or 400 V) is not present.   |          |
| E27                       | <b>BA15..1&amp;Rel1:</b> Status of all binary outputs as binary word. BA15 to BA1 are indicated from left to right. Relay 1 is indicated to the far right.  |          |
| E29                       | <b>n-ref. value raw:</b> Speed reference value before the offset ref. values and the reference value limitation. This is the master reference value for the winder and the free-wheeling reference value for synchronous running.   |          |

<sup>P</sup> Speed depends on pole number **B10**;  $f_{max} = 400$  Hz. With a 4-pole motor, this is 12000 rpm at 400 Hz.

• The power pack must be turned off before these parameters can be changed.

*Italics* These parameters are sometimes not shown depending on which parameters are set.

1) See result table in chap. 13.

2) Only available when **D90**≠1

Parameters which are included in the *normal* menu scope (**A10**=0). For other parameters, select **A10**=1:*extended* or **A10**=2:*service*.

**E** Parameters marked with a "√" can be parameterized separately from each other in parameter record 1 and 2.

11. Parameter Description

| E.. Display Values |  | E |
|--------------------|--|---|
| Para. No.          | Description  |   |
| E30                | <b>Run time:</b> Indicates the current run time. Run time means that the inverter is connected to the power supply.  |   |
| E31                | <b>Enable time:</b> Indicates the active time. Active time means that the motor is powered.  |   |
| E32                | <b>Energy counter:</b> Indicates the total power consumption in kWh  |   |
| E33                | <b>Vi-max-memorized value:</b> The DC-link voltage is monitored continuously. The largest value measured is saved here in non-volatile memory. This value can be reset with <b>A37</b> →1.   |   |
| E34                | <b>I-max-memorized value:</b> The motor current is continuously monitored. The largest value measured is stored here in non-volatile memory. This value can be reset with <b>A37</b> →1.   |   |
| E35                | <b>Tmin-memorized value:</b> The temperature of the inverter is continuously monitored. The smallest value measured is stored here in non-volatile memory. This value can be reset with <b>A37</b> →1.   |   |
| E36                | <b>Tmax-memorized value:</b> The temperature of the inverter is continuously monitored. The greatest value measured is stored here in non-volatile memory. This value can be reset with <b>A37</b> →1.   |   |
| E37                | <b>Pmin-memorized value:</b> The active power of the drive is continuously monitored. The smallest value measured is stored here in non-volatile memory. This value can be reset with <b>A37</b> →1.   |   |
| E38                | <b>Pmax-memorized value:</b> The active power of the drive is continuously monitored. The largest value measured is stored here in non-volatile memory. This value can be reset with <b>A37</b> →1.  |   |
| E40                | <b>Fault type:</b> This parameter allows you to make a selection from archived faults. The inverter stores the last 10 faults in the order in which they occurred. When read out with Controlbox, the number from the fault memory is indicated at the top right. 1 indicates the latest fault, and 10 indicates the oldest fault. The type of fault is shown in plain text in the bottom line. Proceed as follows to select which of the 10 faults will be indicated. Press the <b>#</b> key. The number (1 to 10) of the indicated fault flashes in the top line. The type of fault is indicated in plain text in the bottom line (e.g., "31:short/ground"). The arrow keys can then be used to select the desired fault number. |   |
| E41                | <b>Fault time:</b> The run time at the time of the selected fault is indicated. Selection is the same as for <b>E40</b> .  |   |
| E42                | <b>Fault count:</b> Number of faults of the type of fault selected. Proceed as follows to select the type of fault. Press the <b>#</b> key. A fault code and the fault appear in plain text (e.g., "31:short/ground") in the bottom line. The arrow keys can then be used to select the desired type of fault. The number of faults of this event is shown in the top line (0 to 65535).   |   |
| E45                | <b>Control word:</b> Control of <i>Drivocom</i> device state machine during fieldbus operation with Kommubox   |   |
| E46                | <b>Status word:</b> Status of the device during fieldbus operation with Kommubox. See fieldbus documentation.  |   |
| E47                | <b>n-field-bus:</b> Reference value speed during fieldbus operation with Kommubox  |   |
| E50                | <b>Device:</b> Indication of the exact device type (e.g., FAS 4014)  |   |
| E51                | <b>Software-version:</b> Software version of the inverter (e.g., V4.5)   |   |
| E52                | <b>Device-number:</b> Number of the device from a manufactured series. Same as the number on the nameplate.  |   |
| E53                | <b>Variant-number</b>  |   |
| E54                | <b>Option-board:</b> Indication of the option board detected during initialization.<br>20: none; No option board or external 24 V power supply missing.<br>21: 24V-LC;   |   |
| E55                | <b>Identity-number</b> Can be assigned by the user as desired from 0 to 65535. Can only be write-accessed with FDS Tool or fieldbus.   |   |
| E56                | <b>Parameter set ident. 1:</b> Indicates whether parameters in parameter record 1 were changed. Can be used to detect unauthorized manipulation of parameters. The parameter record ID does not change when the actions " <b>B40</b> phase test" and " <b>B41</b> autotuning" are executed.<br>0: All values are default settings ( <b>A04</b> =1).<br>1: Specified value during initialization by FDS Tool<br>2 to 253: Customer specification/configuration with FDS Tool. Status without change.<br>254: When parameters are changed via fieldbus or via the USS protocol, <b>E56</b> and <b>E57</b> = 254 are set.<br>255: At least one parameter value was changed with the keyboard (Controlbox).                            |   |
| E57                | <b>Parameter set ident. 2:</b> Same as <b>E56</b> but for parameter set 2.   |   |
| E58                | <b>Kommubox:</b> Type of Kommubox for fieldbus communication which is installed on X3 and was automatically detected   |   |

<sup>P</sup> Speed depends on pole number **B10**;  $f_{max} = 400$  Hz. With a 4-pole motor, this is 12000 rpm at 400 Hz.

• The power pack must be turned off before these parameters can be changed.

*Italics* These parameters are sometimes not shown depending on which parameters are set.

1) See result table in chap. 13.

2) Only available when **D90**≠1

Parameters which are included in the *normal* menu scope (**A10**=0). For other parameters, select **A10**=1:*extended* or **A10**=2:*service*.

**E** Parameters marked with a "√" can be parameterized separately from each other in parameter record 1 and 2.

11. Parameter Description

**E.. Display Values** E

| Para. No. | Description   |           |     |                  |     |                 |   |   |   |   |   |   |   |                 |   |   |   |   |                  |   |   |   |   |                  |   |   |   |   |                  |   |   |   |   |                  |   |   |   |   |                  |   |   |   |   |                  |   |   |   |   |                  |
|-----------|---|-----------|-----|------------------|-----|-----------------|---|---|---|---|---|---|---|-----------------|---|---|---|---|------------------|---|---|---|---|------------------|---|---|---|---|------------------|---|---|---|---|------------------|---|---|---|---|------------------|---|---|---|---|------------------|---|---|---|---|------------------|
| E60       | <p><b>Reference value selector:</b> Indicates the result of the binary coding of the fixed reference values specified via binary inputs. At least one binary input must be parameterized for the reference value selector (<b>F3</b>..=1 to 3). The result of the binary coding is indicated with the digits 0 to 7. A fixed reference value/ramp record is assigned to this result.</p> <p>A fixed reference value can also be specified directly with <b>D09</b>. However, <b>E60</b> is not affected by <b>D09</b>.</p> <table border="1" style="float: right;"> <thead> <tr> <th colspan="3">RV select</th> <th rowspan="2">E60</th> <th rowspan="2">Reference Value</th> </tr> <tr> <th>2</th> <th>1</th> <th>0</th> </tr> </thead> <tbody> <tr> <td>0</td> <td>0</td> <td>0</td> <td>0</td> <td>Analog, freq...</td> </tr> <tr> <td>0</td> <td>0</td> <td>1</td> <td>1</td> <td>Fix. ref. val. 1</td> </tr> <tr> <td>0</td> <td>1</td> <td>0</td> <td>2</td> <td>Fix. ref. val. 2</td> </tr> <tr> <td>0</td> <td>1</td> <td>1</td> <td>3</td> <td>Fix. ref. val. 3</td> </tr> <tr> <td>1</td> <td>0</td> <td>0</td> <td>4</td> <td>Fix. ref. val. 4</td> </tr> <tr> <td>1</td> <td>0</td> <td>1</td> <td>5</td> <td>Fix. ref. val. 5</td> </tr> <tr> <td>1</td> <td>1</td> <td>0</td> <td>6</td> <td>Fix. ref. val. 6</td> </tr> <tr> <td>1</td> <td>1</td> <td>1</td> <td>7</td> <td>Fix. ref. val. 7</td> </tr> </tbody> </table> | RV select |     |                  | E60 | Reference Value | 2 | 1 | 0 | 0 | 0 | 0 | 0 | Analog, freq... | 0 | 0 | 1 | 1 | Fix. ref. val. 1 | 0 | 1 | 0 | 2 | Fix. ref. val. 2 | 0 | 1 | 1 | 3 | Fix. ref. val. 3 | 1 | 0 | 0 | 4 | Fix. ref. val. 4 | 1 | 0 | 1 | 5 | Fix. ref. val. 5 | 1 | 1 | 0 | 6 | Fix. ref. val. 6 | 1 | 1 | 1 | 7 | Fix. ref. val. 7 |
| RV select |   |           | E60 | Reference Value  |     |                 |   |   |   |   |   |   |   |                 |   |   |   |   |                  |   |   |   |   |                  |   |   |   |   |                  |   |   |   |   |                  |   |   |   |   |                  |   |   |   |   |                  |   |   |   |   |                  |
| 2         | 1   | 0         |     |                  |     |                 |   |   |   |   |   |   |   |                 |   |   |   |   |                  |   |   |   |   |                  |   |   |   |   |                  |   |   |   |   |                  |   |   |   |   |                  |   |   |   |   |                  |   |   |   |   |                  |
| 0         | 0   | 0         | 0   | Analog, freq...  |     |                 |   |   |   |   |   |   |   |                 |   |   |   |   |                  |   |   |   |   |                  |   |   |   |   |                  |   |   |   |   |                  |   |   |   |   |                  |   |   |   |   |                  |   |   |   |   |                  |
| 0         | 0   | 1         | 1   | Fix. ref. val. 1 |     |                 |   |   |   |   |   |   |   |                 |   |   |   |   |                  |   |   |   |   |                  |   |   |   |   |                  |   |   |   |   |                  |   |   |   |   |                  |   |   |   |   |                  |   |   |   |   |                  |
| 0         | 1   | 0         | 2   | Fix. ref. val. 2 |     |                 |   |   |   |   |   |   |   |                 |   |   |   |   |                  |   |   |   |   |                  |   |   |   |   |                  |   |   |   |   |                  |   |   |   |   |                  |   |   |   |   |                  |   |   |   |   |                  |
| 0         | 1   | 1         | 3   | Fix. ref. val. 3 |     |                 |   |   |   |   |   |   |   |                 |   |   |   |   |                  |   |   |   |   |                  |   |   |   |   |                  |   |   |   |   |                  |   |   |   |   |                  |   |   |   |   |                  |   |   |   |   |                  |
| 1         | 0   | 0         | 4   | Fix. ref. val. 4 |     |                 |   |   |   |   |   |   |   |                 |   |   |   |   |                  |   |   |   |   |                  |   |   |   |   |                  |   |   |   |   |                  |   |   |   |   |                  |   |   |   |   |                  |   |   |   |   |                  |
| 1         | 0   | 1         | 5   | Fix. ref. val. 5 |     |                 |   |   |   |   |   |   |   |                 |   |   |   |   |                  |   |   |   |   |                  |   |   |   |   |                  |   |   |   |   |                  |   |   |   |   |                  |   |   |   |   |                  |   |   |   |   |                  |
| 1         | 1   | 0         | 6   | Fix. ref. val. 6 |     |                 |   |   |   |   |   |   |   |                 |   |   |   |   |                  |   |   |   |   |                  |   |   |   |   |                  |   |   |   |   |                  |   |   |   |   |                  |   |   |   |   |                  |   |   |   |   |                  |
| 1         | 1   | 1         | 7   | Fix. ref. val. 7 |     |                 |   |   |   |   |   |   |   |                 |   |   |   |   |                  |   |   |   |   |                  |   |   |   |   |                  |   |   |   |   |                  |   |   |   |   |                  |   |   |   |   |                  |   |   |   |   |                  |
| E61       | <b>Additional ref. value:</b> Current additional reference value to be added to the reference value being used. Can come from AE1 ( <b>F25</b> =1) or the fieldbus. See block circuit diagram in chap. 16.  |           |     |                  |     |                 |   |   |   |   |   |   |   |                 |   |   |   |   |                  |   |   |   |   |                  |   |   |   |   |                  |   |   |   |   |                  |   |   |   |   |                  |   |   |   |   |                  |   |   |   |   |                  |
| E62       | <b>Actual M-max:</b> Currently effective M-Max as a minimum from M-Max 1 ( <b>C03</b> ), M-Max 2 ( <b>C04</b> ), and the torque resulting from the level on AE1, if the AE1 function is parameterized for torque limit ( <b>F25</b> =2) or power limit ( <b>F25</b> =3) or is from the fieldbus.  |           |     |                  |     |                 |   |   |   |   |   |   |   |                 |   |   |   |   |                  |   |   |   |   |                  |   |   |   |   |                  |   |   |   |   |                  |   |   |   |   |                  |   |   |   |   |                  |   |   |   |   |                  |
| E71       | <b>AE1 scaled:</b> AE1 signal after offset and factor. <b>E71</b> = ( <b>E10</b> + <b>F26</b> ) * <b>F27</b> . Cf. block circuit diagram in chap. 16.   |           |     |                  |     |                 |   |   |   |   |   |   |   |                 |   |   |   |   |                  |   |   |   |   |                  |   |   |   |   |                  |   |   |   |   |                  |   |   |   |   |                  |   |   |   |   |                  |   |   |   |   |                  |
| E80       | <b>Operating condition:</b> Indicates the current operating state as shown by the operational display. Cf. chapter 14 (operating states). Useful for fieldbus polling or serial remote control.   |           |     |                  |     |                 |   |   |   |   |   |   |   |                 |   |   |   |   |                  |   |   |   |   |                  |   |   |   |   |                  |   |   |   |   |                  |   |   |   |   |                  |   |   |   |   |                  |   |   |   |   |                  |
| E81       | <b>Event level:</b> Indicates whether a current event is present. The type of event is indicated in <b>E82</b> . Useful for fieldbus polling or serial remote control.<br><i>0: inactive;</i> No event is present.<br><i>1: message;</i><br><i>2: warning;</i><br><i>3: fault;</i>  |           |     |                  |     |                 |   |   |   |   |   |   |   |                 |   |   |   |   |                  |   |   |   |   |                  |   |   |   |   |                  |   |   |   |   |                  |   |   |   |   |                  |   |   |   |   |                  |   |   |   |   |                  |
| E82       | <b>Event name:</b> Indicates the current event/fault. Cf. table in chap. 15. Useful for fieldbus polling or serial remote control.  |           |     |                  |     |                 |   |   |   |   |   |   |   |                 |   |   |   |   |                  |   |   |   |   |                  |   |   |   |   |                  |   |   |   |   |                  |   |   |   |   |                  |   |   |   |   |                  |   |   |   |   |                  |
| E83       | <b>Warning time:</b> The time remaining until the fault is triggered is indicated for the active warnings. This time can be changed via FDS Tool. Useful for fieldbus polling or serial remote control.   |           |     |                  |     |                 |   |   |   |   |   |   |   |                 |   |   |   |   |                  |   |   |   |   |                  |   |   |   |   |                  |   |   |   |   |                  |   |   |   |   |                  |   |   |   |   |                  |   |   |   |   |                  |
| E84       | <b>Active parameter set:</b> Indicates the current parameter record. Cf. chapter 9.4. Useful for fieldbus polling or serial remote control.<br><i>1: parameter set 1;</i><br><i>2: parameter set 2;</i>   |           |     |                  |     |                 |   |   |   |   |   |   |   |                 |   |   |   |   |                  |   |   |   |   |                  |   |   |   |   |                  |   |   |   |   |                  |   |   |   |   |                  |   |   |   |   |                  |   |   |   |   |                  |
| E100...   | Parameters <b>E100</b> and above are used to control and parameterize the inverters by fieldbus. For details, see the documentation of the individual fieldbus systems.   |           |     |                  |     |                 |   |   |   |   |   |   |   |                 |   |   |   |   |                  |   |   |   |   |                  |   |   |   |   |                  |   |   |   |   |                  |   |   |   |   |                  |   |   |   |   |                  |   |   |   |   |                  |

**F.. Control Interface** E

| Para. No. | Description  |
|-----------|--|
| F00       | <p><b>Relay2-function:</b> Functions of relay 2 (X2.3 - 2.4)</p> <p><i>0: inactive;</i></p> <p><b>1: brake;</b> Used to control a brake. See <b>F01</b>, <b>F02</b> and <b>F06</b> and <b>F07</b>. See also chap. 8.6.</p> <p><b>2: standstill;</b> Output active (relay closes) when speed 0 rpm ±<b>C40</b> is reached.</p> <p><b>3: reference value-reached;</b> When <b>C60</b>=1 (speed mode): output is active when speed ref. value is within ±<b>C40</b>.</p> <p><b>4: torque-limit;</b> Relay closes when the active torque limit is reached. See <b>E62</b>.</p> <p><b>5: warning;</b> Relay closes when a warning occurs.</p> <p><b>6: operation range;</b> Relay closes when the defined operational range (<b>C41</b> to <b>C46</b>) is exited.</p> <p><b>7: active parameter set;</b> Only works when <b>F00</b>=7 is parameterized in both param. rec. Low signal (i.e., relay open) means that param. rec. 1 is active. High signal (i.e., relay closed) means that param. rec. 2 is active. The signal arrives <u>before</u> the new parameter record takes effect and can be used, for example, for contactor control for a two-motor drive. Cf. chap. 9.4.</p> <p><i>8: to 13: inactive;</i></p> <p><b>14: clockwise;</b> Speed n&gt;0. For zero crossing, hysteresis with <b>C40</b>.</p> <p><b>15: fault;</b> A fault has occurred.</p> <p><b>16: inhibited;</b> See run mode "12.inhibited" in chap. 14.</p> <p><b>17: BE1;</b> Route binary input. In addition to galvanic isolation, also used to read binary inputs via ASi bus.</p> <p><b>18: BE2;</b> Cf. selection "17:BE1."</p> <p><i>19: to 21: inactive</i></p> |

<sup>P</sup> Speed depends on pole number **B10**;  $f_{max} = 400$  Hz. With a 4-pole motor, this is 12000 rpm at 400 Hz.

• The power pack must be turned off before these parameters can be changed.

*Italics* These parameters are sometimes not shown depending on which parameters are set.

1) See result table in chap. 13.

2) Only available when **D90**≠1

Parameters which are included in the *normal* menu scope (**A10**=0). For other parameters, select **A10**=1:*extended* or **A10**=2:*service*.

**E** Parameters marked with a "√" can be parameterized separately from each other in parameter record 1 and 2.

11. Parameter Description

| F.. Control Interface |   | E   |
|-----------------------|---|---|
| Para. No.             | Description   |   |
| F00<br>Continued      | <p><b>22: ready for reference value;</b> The drive is powered. Magnetization is established. Ref. value can be specified.</p> <p><b>23: to 27: inactive;;</b></p> <p><b>28: BE3;</b> Cf. selection "17:BE1."</p> <p><b>29: BE4;</b></p> <p><b>30: BE5;</b></p> <p><b>31: inactive;</b></p> <p><b>32: parameters active;</b> Low signal means internal parameter conversions not completed. Useful for the handshake with a higher level controller when converting parameter records, and similar.</p>  | <div style="border: 1px solid black; padding: 5px; width: fit-content;"> <p>Example for "32:parameters active" when writing parameters via fieldbus:</p> <p>The diagram shows a horizontal line representing a signal. A low pulse (indicated by a lightning bolt symbol) occurs during the 'Send parameter' and 'Reply' phases. After the 'Reply' phase, the signal goes high (indicated by a lightning bolt symbol) during the 'Parameter accepted' phase.</p> </div> |
| F01                   | <p><b>Brake release:</b> Only if <b>F00=1</b> (brake) and <b>B20≠2</b> (control mode ≠ vector control with feedback), otherwise <b>F06</b>. If the reference value exceeds the set speed value, the brake releases (relay 2=closes).</p> <p><i>Value range in rpm: 0 to 300*</i></p>  | √   |
| F02                   | <p><b>Brake set:</b> Only if <b>F00=1</b> (brake) and <b>B20≠2</b> (control mode ≠ vector control with feedback), otherwise <b>F07</b>. When the drive is halted to a standstill by a "halt" or a "quick stop" command, the brake is applied when the set speed value is passed below (relay 2=opens).</p> <p><i>Value range in rpm: 0 to 300*</i></p>  | √   |
| F03                   | <p><b>Relay 2 t-on:</b> Only if <b>F00&gt;0</b>. Causes a delay in switch-on of relay 2. Can be combined with all functions of relay 2. The related function must be present for at least t-on so that the relay switches.</p> <p><i>Value range in sec: 0 to 5.024</i></p>   | √   |
| F04                   | <p><b>Relay 2 t-off:</b> Only if <b>F00&gt;0</b>. Causes a delay in switch-off of relay 2. Can be combined with all functions of relay 2.</p> <p><i>Value range in sec: 0 to 5.024</i></p>  | √   |
| F05                   | <p><b>Relay 2 invert:</b> Only if <b>F00&gt;0</b>. Permits the relay-2 signal to be inverted. Inversion occurs after the function switch-on/switch-off delay (<b>F04/F03</b>). Can be combined with all functions of relay 2.</p> <p><i>Value range: 0 to 1</i></p>   | √   |
| F06                   | <p><b>t-brake release:</b> Only if <b>F00=1</b> (brake) and <b>B20=2</b> (vector control with feedback). Defines the amount of time the brake is released. <b>F06</b> must be selected approximately 30 msec greater than the time t<sub>1</sub> in section M of the STÖBER MGS catalog. When the enable is granted or the halt/quick stop signal is removed, startup is delayed by the time <b>F06</b>. See also <b>B25</b>.</p> <p><i>Value range in sec: 0 to 5.024</i></p>  | √   |
| F07                   | <p><b>t-brake set:</b> Only if <b>F00=1</b> (brake) and <b>B20=2</b> (vector control with feedback). Defines the time the brake is applied. <b>F07</b> must be selected approximately 30 msec greater than the time t<sub>1</sub> (MGS catalog). When the enable and halt/quick stop is removed, the drive still remains under control for the time <b>F07</b>.</p> <p>Time t<sub>1</sub> → scanning time t<sub>21</sub> ⚠ t<sub>21</sub> varies with switching on AC or DC side! ⚠</p> <p><i>Value range in sec: 0 to 5.024</i></p>  | √   |
| F10                   | <p><b>Relay 1-function:</b> Relay 1 is closed when the inverter is ready for operation. The opening of the relay can be controlled by scanning the status of relay 1 via parameter <b>E17</b>.</p> <p><b>0: fault;</b> Relay opens when a fault occurs.</p> <p><b>1: fault and warning;</b> Relay opens when a fault or warning occurs.</p> <p><b>2: fault and warning and message;</b> Relay open when a fault, warning or message occurs. If auto-reset (<b>A32=1</b>) is active, the switching of the relay is suppressed until all auto-acknowledgment attempts have been exhausted.</p>  | √   |
| F19                   | <p><b>Quick stop end:</b> Only if <b>C60=1</b>. <b>F19</b> is available starting with SV 4.5E. It specifies when the quick stop ramp can be concluded.</p> <p><b>0: Standstill;</b> With the rising edge of the quick stop signal (or removal of the enable for <b>F38&gt;0</b>), the drive brakes down to standstill ("zero reached" message) even when the quick stop signal (or enable off) was only briefly queued.</p> <p><b>1: No stop;</b> When the quick stop signal disappears or the enable returns, the drive immediately accelerates again to the current reference value.</p>  | √   |
| F25•                  | <p><b>AE1-function:</b> Function of analog input 1 (X1.2 – X1.3).</p> <p><b>0: inactive;</b></p> <p><b>1: additional reference value;</b> Additional reference value input. Takes effect regardless of which operation input is selected. Is added to the running reference value (<b>A30</b>). 100% control of AE1 is 100 Hz (3000 rpm for 4-pole motor). Can be scaled with <b>F26</b> and <b>F27</b>.</p> <p><b>2: torque-limit;</b> Additional torque limit. ((10 V + <b>F26</b>) x <b>F27</b>) = nominal motor torque. Active torque limit is the minimum from M-Max 1 (<b>C03</b>), M-Max 2 (<b>C04</b>) and the level on analog input 1.</p> | √   |

<sup>P</sup> Speed depends on pole number **B10**; f<sub>max</sub> = 400 Hz. With a 4-pole motor, this is 12000 rpm at 400 Hz.

• The power pack must be turned off before these parameters can be changed.

*Italics* These parameters are sometimes not shown depending on which parameters are set.

1) See result table in chap. 13.

2) Only available when **D90≠1**

Parameters which are included in the *normal* menu scope (**A10=0**). For other parameters, select **A10=1:extended** or **A10=2:service**.

**E** Parameters marked with a "√" can be parameterized separately from each other in parameter record 1 and 2.

11. Parameter Description

| F.. Control Interface |  | E |
|-----------------------|--|---|
| Para. No.             | Description  |   |
| F25•<br>Continued     | <p><b>3: power-limit</b>; External power limit whereby 10 V = nominal motor power</p> <p><b>4: reference value-factor</b>; The main reference value on AE1 is multiplied by the RV-factor (10 V = 100%).</p> <p><b>5: to 7: inactive</b>;</p> <p><b>8: rotation field magnet moment</b>; Torque control for rotation field magnets. V/f-control (<b>B20=0</b>) is used. The speed is set to the nominal value via the fixed reference value, for example. <b>F20=8</b> can be used to affect the motor voltage via AE1. Since torque corresponds to the square of the motor voltage, this voltage is weighted with the <u>root</u> of the AE1 signal.</p> <p><b>9: n-Max</b>; Limitation of the maximum speed via external voltage</p> <p><b>10: reference value</b>; Reference value for speed or torque (AE1 is typically parameterized to "10:reference value").</p>  | √ |
| F26                   | <p><b>AE1-offset</b>: An offset on analog input 1 (X1.2 – X1.3) can be corrected. To do this, jumper terminals X1.2 and X1.3. Then observe the AE1 level in parameter <b>E10</b>, and enter it with the reverse sign in parameter <b>F26</b>. For example, if parameter <b>E10</b> indicates 1.3%, <b>F26</b> must be parameterized to -1.3%.</p> <p><i>Value range in %: -400 to 0 to 400</i></p>   | √ |
| F27                   | <p><b>AE1-gain</b>: The signal present on analog input 1 is added to the AE1 offset (<b>F26</b>) and then multiplied by this factor. Depending on <b>F25</b>, <b>F27</b> is scaled as shown below.</p> <p><b>F25= 1</b> ⇒ 10 V = <b>F27</b> x 100 Hz (3000 rpm)*</p> <p><b>F25= 2</b> ⇒ 10 V = <b>F27</b> x nominal motor torque</p> <p><b>F25= 3</b> ⇒ 10 V = <b>F27</b> x nominal motor power</p> <p><b>F25= 4</b> ⇒ 10 V = <b>F27</b> x multiplication with 1.0</p> <p><b>F25= 6</b> ⇒ 10 V = <b>F27</b> x path in <b>I70</b></p> <p><b>F25= 8</b> ⇒ 10 V = <b>F27</b> x nominal motor voltage</p> <p><b>F25= 9</b> ⇒ 10 V = <b>F27</b> x 100 Hz (3000 rpm)*</p> <p><b>F25=10</b> ⇒ 10 V = <b>F27</b> x 100% input of ref. val. curve</p> <p><b>Example</b>: If <b>F25=1</b> and <b>F27=50%</b>, the offset is 1500 rpm at 10 V and AE1.</p> <p><i>Value range in %: -400 to 100 to 400</i></p> <div style="border: 1px solid black; padding: 5px; margin-top: 10px;"> <p>* 4-pole motors: 100 Hz corresponds to 3000 rpm. Other motors: Speed must be converted.</p> <p><b>B10=2</b> → 100 Hz = 6000 rpm<br/><b>B10=6</b> → 100 Hz = 2000 rpm</p> </div>   | √ |
| F30                   | <p><b>BE-logic</b>: Logical link when several BEs are programmed for the same function</p> <p><b>0: OR</b>;</p> <p><b>1: AND</b>;</p>  | √ |
| F31•                  | <p><b>BE1-function</b>: All binary inputs can be programmed as desired. Selection points 0 to 13 and those greater than 16 are identical for all binary inputs. If the same function is used by several BEs, <b>F30</b> can be used to program a logical link. Inversion can be performed with <b>F51</b> to <b>F55</b>.</p> <p><b>0: inactive</b>;</p> <p><b>1: reference value-select 0</b>; Binary coded selection of fixed reference values. The result of the reference value selection is indicated in <b>E60</b>.</p> <p><b>2: reference value-select 1</b>; See above.</p> <p><b>3: reference value-select 2</b>; See above.</p> <p><b>4: motorpoti up</b>; If <b>D90=1</b>, two binary inputs can be used to simulate a motor potentiometer. One BE must be programmed as "4:Motorpoti up," and another BE must be programmed as "5:Motorpoti dwn." See also <b>D90</b>.</p> <p><b>5: motorpoti down</b>; Same as "4:Motorpoti up."</p> <p><b>6: direction of rotation</b>; Negation of the current reference value</p> <p><b>7: additional enable</b>; BE handles the function of an additional enable (i.e., a fault can also be acknowledged via this additional enable). The drive is not enabled unless the "enable" input (X1.6) and the binary input have a high signal.</p> <p><b>8: halt</b>; With high signal, drive is slowed with the selected deceleration ramp. If <b>F00=1</b>, the brake is then applied. <b>Ramps</b>: Analog RV specification/motor potentiometer: <b>D01</b>; fixed reference values: <b>D12</b> to <b>D72</b>;</p> <p><b>9: quick stop</b>; When a rising edge occurs, the drive is slowed with the selected decel-quick ramp (<b>D81</b>). The brake is then applied if <b>F00=1</b>. A brief high pulse (≥4 msec) on the binary input is sufficient to trigger the quick stop. Termination of quick stop is impossible until speed <b>C40</b> is passed below. Cf. also <b>F38</b>. <b>Caution</b>: Torque limit <b>C04</b> is always active for quick stop.</p> <p><b>10: torque select</b>; Switches between the torque limits M-Max 1 (<b>C03</b>) and M-Max 2 (<b>C04</b>).<br/>Low signal=M-Max 1. High signal = M-Max 2.</p> <p><b>11: parameter set-select</b>; A parameter record can only be selected via BE if <b>A41=0</b>. This means that this binary input must be set to 11 in both parameter records. A low signal means that parameter record 1 is selected. A high signal means that parameter record 2 is selected. When <b>A34=0</b> (auto-start = inactive), the selected parameter record is not switched until the enable is removed. Cf. chap. 9.4.</p> | √ |

<sup>P</sup> Speed depends on pole number **B10**;  $f_{max} = 400$  Hz. With a 4-pole motor, this is 12000 rpm at 400 Hz.

• The power pack must be turned off before these parameters can be changed.

*Italics* These parameters are sometimes not shown depending on which parameters are set.

1) See result table in chap. 13. 2) Only available when **D90≠1**

Parameters which are included in the *normal* menu scope (**A10=0**). For other parameters, select **A10=1:extended** or **A10=2:service**.

**E** Parameters marked with a "√" can be parameterized separately from each other in parameter record 1 and 2.

11. Parameter Description

| F.. Control Interface |  | E                                     |     |         |   |   |                                       |   |   |                    |   |   |                           |   |   |      |  |
|-----------------------|--|---------------------------------------|-----|---------|---|---|---------------------------------------|---|---|--------------------|---|---|---------------------------|---|---|------|--|
| Para. No.             | Description  |                                       |     |         |   |   |                                       |   |   |                    |   |   |                           |   |   |      |  |
| F31•<br>Continued     | <p><b>12: extern fault;</b> Permits fault messages of the periphery to be evaluated. The inverter evaluates a rising edge on the binary input and assumes "44:ext.fault." If several binary inputs are programmed for external fault, the rising edge can only be evaluated when a low signal is present on the other binary inputs programmed for "12:ext.fault."</p> <p><b>13: fault reset;</b> A fault which is no longer queued can be acknowledged with a rising edge. If several binary inputs are programmed for acknowledgment, the rising edge can only be evaluated when a low signal is present on the other binary inputs programmed with "13:faultReset."</p> <p><b>14: counter-clockwise V3.2;</b> By programming F31=14 and F32=14, the direction of rotation specification can be simulated by inverters with the V3.2 software. In this case, the functions "direction of rotation," "halt," and "quick stop" may not be assigned to other binary inputs.</p> <table border="0"> <tr> <td>BE1</td> <td>BE2</td> <td>Command</td> </tr> <tr> <td>0</td> <td>0</td> <td>Quick stop (if F38≠0) or halt (F38=0)</td> </tr> <tr> <td>0</td> <td>1</td> <td>Clockwise rotation</td> </tr> <tr> <td>1</td> <td>0</td> <td>Counterclockwise rotation</td> </tr> <tr> <td>1</td> <td>1</td> <td>Halt</td> </tr> </table> <p>15: and 16: inactive;</p> <p><b>17: tip +;</b> Manual traversing in the positive direction (<b>tipping</b>). Selection "8:halt" must be active. In speed operating mode (C60=1), the operational state "22:tip" appears on Controlbox and the motor stops as called for in "8:halt" (n=0).</p> <p><b>18: tip -;</b> Manual traversing in the negative direction</p> <p>19: to 20: inactive;</p> <p><b>21: stop +;</b> Limit switch at the positive end of the traversing area.</p> <p><b>22: stop -;</b> Limit switch at the negative end of the traversing area. In speed mode, the direction of rotation is inhibited.</p> <p>23: to 31: inactive;</p> <p><b>32: brake release;</b> Manual brake control via a BE (higher priority than the internal brake function)</p> | BE1                                   | BE2 | Command | 0 | 0 | Quick stop (if F38≠0) or halt (F38=0) | 0 | 1 | Clockwise rotation | 1 | 0 | Counterclockwise rotation | 1 | 1 | Halt |  |
| BE1                   | BE2  | Command                               |     |         |   |   |                                       |   |   |                    |   |   |                           |   |   |      |  |
| 0                     | 0  | Quick stop (if F38≠0) or halt (F38=0) |     |         |   |   |                                       |   |   |                    |   |   |                           |   |   |      |  |
| 0                     | 1  | Clockwise rotation                    |     |         |   |   |                                       |   |   |                    |   |   |                           |   |   |      |  |
| 1                     | 0  | Counterclockwise rotation             |     |         |   |   |                                       |   |   |                    |   |   |                           |   |   |      |  |
| 1                     | 1  | Halt                                  |     |         |   |   |                                       |   |   |                    |   |   |                           |   |   |      |  |
| F32•                  | <p><b>BE2-function:</b> 0 to 13 and starting with 15, see F31. 14:clockwise V3.2;</p> <p>Value range: 0 to 6 to 32</p>   | √                                     |     |         |   |   |                                       |   |   |                    |   |   |                           |   |   |      |  |
| F33•                  | <p><b>BE3-function:</b> 0 to 13 and starting with 15, see F31.</p> <p><b>14: encoderSignal 0;</b> Only if B20=2 (vector control with feedback). The "zero signal" (= track "C," one pulse per rotation) of the incremental encoder. This signal is not required for the function of "vector control with feedback."</p> <p>Value range: 0 to 1 to 32</p>   | √                                     |     |         |   |   |                                       |   |   |                    |   |   |                           |   |   |      |  |
| F34•                  | <p><b>BE4-function:</b> 0 to 13 and starting with 15, see F31.</p> <p><b>14: encoderSignal A;</b> Only if B20=2 (vector control with feedback). The "A signal" of the incremental encoder.</p> <p>Value range: 0 to 2 to 32</p>  | √                                     |     |         |   |   |                                       |   |   |                    |   |   |                           |   |   |      |  |
| F35•                  | <p><b>BE5-function:</b> 0 to 13 and starting with 16, see F31.</p> <p><b>14: frequency-RV;</b> The inverter is parameterized to the frequency reference value specification. Analog input 1 (X1.2 to 4) is ignored. The maximum frequency entered under F37 corresponds to a reference value output of 100%. Frequencies under 1 Hz are interpreted as 0% output. The frequency RV is further processed internally with the reference value characteristic (D02 to D05) and the ramp generator (D00/D01).</p> <p><b>15: encoderSignal B;</b> Only if B20=2 (vector control with feedback). This is the "B signal" of the incremental encoder. This signal is a mandatory requirement for the function "vector control with feedback."</p> <p>Value range: 0 to 32</p>  | √                                     |     |         |   |   |                                       |   |   |                    |   |   |                           |   |   |      |  |
| F36•                  | <p><b>BE-increments:</b> When an incremental encoder is used on BE4 and BE5, the number of increments per revolution must be entered here. If the incremental encoder is not mounted on the motor shaft, the step-down ratios may have to be considered.</p> <p>Value range in I/R: 30 to 1024 to 4096</p>   | √                                     |     |         |   |   |                                       |   |   |                    |   |   |                           |   |   |      |  |
| F37•                  | <p><b>Fmax frequency-ref. value:</b> Only if binary input 5 is parameterized to frequency reference value (F35=14). Maximum permissible frequency. Frequency F37 corresponds to a reference value output of 100%. The fixed minimum frequency of 100 Hz corresponds to a reference value output of 0%.</p> <p>Value range in kHz: 3 to 51.2</p>  | √                                     |     |         |   |   |                                       |   |   |                    |   |   |                           |   |   |      |  |

<sup>P</sup> Speed depends on pole number B10; f<sub>max</sub> = 400 Hz. With a 4-pole motor, this is 12000 rpm at 400 Hz.

• The power pack must be turned off before these parameters can be changed.

*Italics* These parameters are sometimes not shown depending on which parameters are set.

1) See result table in chap. 13. 2) Only available when D90≠1

Parameters which are included in the normal menu scope (A10=0). For other parameters, select A10=1:extended or A10=2:service.

**E** Parameters marked with a "√" can be parameterized separately from each other in parameter record 1 and 2.



11. Parameter Description

**F.. Control Interface** E

| Para. No.   | Description   |   |
|-------------|---|---|
| F38         | <b>Quick stop: F38</b> controls the automatic triggering of quick stop under certain operating conditions (brake on quick stop ramp <b>D81</b> ).<br><i>0: inactive</i> ; Quick stop can only be triggered by the BE function "9:Quick stop."<br><b>1: enable and clockwise/counter-clockwise</b> ; Important for use of two direction-of-rotation inputs (i.e., clockwise and counterclockwise) on BE1 and BE2. Quick stop is triggered when BE1 is low and BE2 is low or when the enable is removed (also reference value enable <b>D07</b> or additional enable via BE).<br><b>2: fault and enable</b> ; In addition to the BE function "9:Quick stop," removal of the enable and "non-dangerous" faults (e.g., "46:Low voltage") causes the quick stop. | √ |
| F51 to F55• | <b>BE1-invert to BE5-invert</b><br><i>0: inactive</i> ; No inversion.<br><b>1: active</b> ; Input is inverted. Useful for the HALT signal or limit switch, for example.   | √ |
| F81•        | <b>Realy2 function</b> : Selection values correspond to parameter <b>F00</b> .<br><i>Value range: 0 to 32</i>   | √ |

**M.. Menu Skip (Menu jump destinations)** E

| Para. No. | Description  |  |
|-----------|--|--|
| M50       | <b>F1-jump to</b> : Parameter provided by the F1 function key for editing. Depending on the device function, some parameters may not be shown and cannot be selected.<br><i>Value range: A00 to E50 to N44</i> |  |
| M51       | <b>F1-lower limit</b> :<br><i>Value range</i> : Depends on the parameter selected in <b>M50</b>  |  |
| M52       | <b>F1-upper limit</b> :<br><i>Value range</i> : Depends on the parameter selected in <b>M50</b>  |  |

⇒ The jump destinations F2 to F4 are designed identically. Jump destination F2 is in **M60 to M62**, and so on. If several jump destinations (**M50; M60; M70 or M80**) are parameterized to the same coordinates (e.g., **J10**), the lower, upper limit of the lowest jump destination takes effect.

**U.. Protective Functions** E

| Para. No. | Description   |  |
|-----------|---|--|
| U00       | <b>Level low voltage</b> : Is activated when the value <b>U00</b> set in <b>A35</b> is passed below.<br><b>2: warning</b> ; After expiration of the tolerance time in <b>U01</b> , the device assumes fault mode (for E46, see chap. 15).<br><b>3: fault</b> ; The device assumes malfunction mode (for E46, see chap. 15) immediately after the value in <b>A35</b> is passed below.   |  |
| U01       | <b>Time low voltage</b> : Can only be set with <b>U00=2:warning</b> . Defines the time during which triggering of undervoltage monitoring is tolerated. After expiration of this time, the device assumes fault mode.<br><i>Value range in s: 1 to 2 to 10</i>  |  |
| U10       | <b>Level temp. limit mot. i2t</b> : Parallel to the monitoring of the positor line in the motor, the FAS simulates the motor temperature via an i <sup>2</sup> t model. The percentage of load of the motor is indicated in parameter <b>E23</b> . If the value in <b>E23</b> is greater than 100%, <b>U10</b> is triggered.<br><i>0: off</i> ; Device does not react when <b>U10</b> is triggered.<br><b>1: message</b> ; Triggering of <b>U10</b> is only indicated. The device continues to be ready for operation.<br><b>2: warning</b> ; After expiration of the tolerance time in <b>U11</b> , the device assumes fault mode (for E45, see chap. 15). |  |
| U11       | <b>Time temp. limit mot. i2t</b> : Can only be set with <b>U10=2:warning</b> . Defines the time during which the triggering of i <sup>2</sup> t monitoring is tolerated. After expiration of the set time, the device assumes fault mode.<br><i>Value range in s: 1 to 30 to 120</i>  |  |
| U20       | <b>Level drive overload</b> : If the calculated torque in static operation exceeds the current M-Max in <b>E62</b> , <b>U20</b> is triggered.<br><i>0: off</i> ; Device does not react when <b>U10</b> is triggered.<br><b>1: message</b> ; Triggering of <b>U20</b> is only indicated. The device continues to be ready for operation.<br><b>2: warning</b> ; After expiration of the tolerance time in <b>U21</b> , the device assumes fault mode (for E47, see chap. 15).<br><b>3: fault</b> ; The device immediately assumes fault mode (for E47, see chap. 15) after <b>U20</b> is triggered.  |  |
| U21       | <b>Time drive overload</b> : Can only be set with <b>U20=2:warning</b> . Defines the time during which triggering of undervoltage monitoring is tolerated. After expiration of this time, the device assumes fault mode.<br><i>Value range in s: 1 to 10 to 120</i>   |  |
| U22       | <b>Text drive overload</b> : The entry "drive overload" can be varied to suit user-specific requirements.<br><i>Value range: 0 to "drive overload" to 11</i>  |  |

<sup>P</sup> Speed depends on pole number **B10**;  $f_{max} = 400$  Hz. With a 4-pole motor, this is 12000 rpm at 400 Hz.

• The power pack must be turned off before these parameters can be changed.

*Italics* These parameters are sometimes not shown depending on which parameters are set.

1) See result table in chap. 13.

2) Only available when **D90≠1**

Parameters which are included in the *normal* menu scope (**A10=0**). For other parameters, select **A10=1:extended** or **A10=2:service**.

E Parameters marked with a "√" can be parameterized separately from each other in parameter record 1 and 2.

11. Parameter Description

| <b>U.. Protective Functions</b> |  | <b>E</b> |
|---------------------------------|--|----------|
| <i>Para. No.</i>                | <i>Description</i>   |          |
| U30                             | <p><b>Level acceleration overload:</b> If the calculated torque exceeds the current M-Max in <b>E62</b> during the acceleration ramp, <b>U30</b> is triggered.</p> <p><i>0: off;</i> Device does not react when <b>U30</b> is triggered.</p> <p><i>1: message;</i> Triggering of <b>U30</b> is only indicated. The device continues to be ready for operation.</p> <p><i>2: warning;</i> After expiration of the tolerance time in <b>U31</b>, the device assumes fault mode (for E48, see chap. 15).</p> <p><i>3: fault;</i> The device immediately assumes fault mode (for E48, see chap. 15) after <b>U30</b> is triggered.</p>   |          |
| U31                             | <p><b>Time acceleration overload:</b> Can only be set with <b>U30=2:warning</b>. Defines the time during which drive overload during acceleration is tolerated. After expiration of the set time, the device assumes fault mode.</p> <p><i>Value range in s:</i> 1 to 5 to 10</p>  |          |
| U32                             | <p><b>Text acceleration overload:</b> The entry "acceleration overload" can be varied to suit user-specific requirements.</p> <p><i>Value range:</i> 0 to "acceleration overload" to 11</p>  |          |
| U40                             | <p><b>Level break overload:</b> If the calculated torque exceeds the current M-Max in <b>E62</b> during the deceleration ramp, <b>U40</b> is triggered.</p> <p><i>0: off;</i> Device does not react when <b>U40</b> is triggered.</p> <p><i>1: message;</i> Triggering of <b>U40</b> is only indicated. The device continues to be ready for operation.</p> <p><i>2: warning;</i> After expiration of the tolerance time in <b>U41</b>, the device assumes fault mode (for E49, see chap. 15).</p> <p><i>3: fault;</i> The device immediately assumes fault mode (for E49, see chap. 15) after <b>U40</b> is triggered.</p>  |          |
| U41                             | <p><b>Time break overload:</b> Can only be set with <b>U40=2:warning</b>. Defines the time during which an overload of the drive during deceleration is tolerated. After expiration of the set time, the device assumes fault mode.</p> <p><i>Value range in s:</i> 1 to 5 to 10</p>   |          |
| U42                             | <p><b>Text break overload:</b> The entry "break overload" can be varied to suit user-specific requirements.</p> <p><i>Value range:</i> 0 to "break overload" to 11</p>   |          |
| U50                             | <p><b>Level operating range:</b> If one or more of the parameters <b>C41</b> to <b>C46</b> are violated, <b>U50</b> is triggered.</p> <p><i>0: off;</i> Device does not react when <b>U50</b> is triggered.</p> <p><i>1: message;</i> Triggering of <b>U50</b> is only indicated. The device continues to be ready for operation.</p> <p><i>2: warning;</i> After expiration of the tolerance time in <b>U51</b>, the device assumes fault mode (for E50, see chap. 15).</p> <p><i>3: fault;</i> The device immediately assumes fault mode (for E50, see chap. 15) after <b>U50</b> is triggered.</p>  |          |
| U51                             | <p><b>Time operating range:</b> Can only be set with <b>U50=2:warning</b>. Defines the time tolerated outside the work area. After expiration of the set time, the device assumes fault mode.</p> <p><i>Value range in s:</i> 1 to 10 to 120</p>   |          |
| U52                             | <p><b>Text operating range:</b> The entry "operating range" can be varied to suit user-specific requirements.</p> <p><i>Value range:</i> 0 to "operating range" to 11</p>  |          |
| U60                             | <p><b>Level following error:</b> If the value in <b>I84</b> exceeds the value of <b>I21</b>, <b>U60</b> is triggered.</p> <p><i>0: off;</i> Device does not react when <b>U60</b> is triggered.</p> <p><i>1: message;</i> Triggering of <b>U6</b> is only indicated. The device continues to be ready for operation.</p> <p><i>2: warning;</i> After expiration of the tolerance time in <b>U61</b>, the device assumes fault mode (for E54, see chap. 15).</p> <p><i>3: fault;</i> The device immediately assumes fault mode (for E54, see chap. 15) after <b>U60</b> is triggered.</p>   |          |
| U61                             | <p><b>Time following error:</b> Can only be set with <b>U60=2:warning</b>. Defines the time during which the value in <b>I21</b> is exceeded. After expiration of the set time, the devices assumes fault mode.</p> <p><i>Value range in ms:</i> 0 to 500 to 32767</p>   |          |
| U70                             | <p><b>Level posi. Refused:</b> If the target position is located outside software stops <b>I50</b> and <b>51</b> or an absolute process block is started in an unreferenced state (<b>I86=0</b>), <b>U70</b> is triggered.</p> <p><i>0: off;</i> Device does not react when <b>U70</b> is triggered.</p> <p><i>1: message;</i> Triggering of <b>U7</b> is only indicated. The device continues to be ready for operation.</p> <p><i>2: warning;</i> After expiration of the tolerance time of 1 sec, the device assumes fault mode (for E51, see chap. 15).</p> <p><i>3: fault;</i> The device immediately assumes fault mode (for E51, see chap. 15) after <b>U70</b> is triggered.</p> |          |

<sup>P</sup> Speed depends on pole number **B10**;  $f_{max} = 400$  Hz. With a 4-pole motor, this is 12000 rpm at 400 Hz.

• The power pack must be turned off before these parameters can be changed.

*Italics* These parameters are sometimes not shown depending on which parameters are set.

1) See result table in chap. 13. 2) Only available when **D90**≠1

Parameters which are included in the *normal* menu scope (**A10=0**). For other parameters, select **A10=1:extended** or **A10=2:service**.

**E** Parameters marked with a "√" can be parameterized separately from each other in parameter record 1 and 2.

12. Option board 24 V-LC

**12 OPTION BOARD 24 V-LC**

The 24 V-LC option board for POSIDRIVE® FAS 4000 powers the following.

- The internal electronics
- The 15 V voltage on terminal X1.12 (can be used for operation of a pulse encoder)
- The Kommubox for CAN or PROFIBUS parallel to the power input (400 V or 230 V).

This provides the following advantages.

- In operating mode "position" (C60=2:position - only with Posi-Upgrade) the actual and reference positions are retained when the inverter is disconnected from the power supply.
- When the inverter is addressed via fieldbus, bus communication is maintained even when the power supply is turned off.
- The inverter can be parameterized without power.

**Note:** The 24 V power supply does not change the function of the ready-for-operation relay (i.e., the relay opens when the DC link voltage drops below the value set in A35).

**PIN-ASSIGNMENT**

Supply voltage: 20.4 V to 28.8 V DC / typ. 24 V  
 Charging rate: max. 500 mA

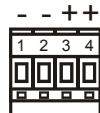

**ASSEMBLY**

**Bend tab straight**

**Open housing**

Unscrew two screws on the front

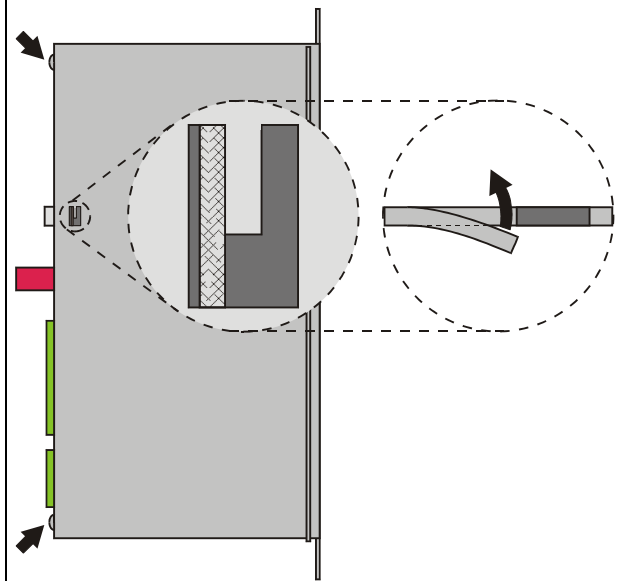

**Mount the option board**

- Mount board (upper front) parallel to the front above X3 plug connector.
- Bend housing plate forward approx. 4 mm on upper side for mounting.

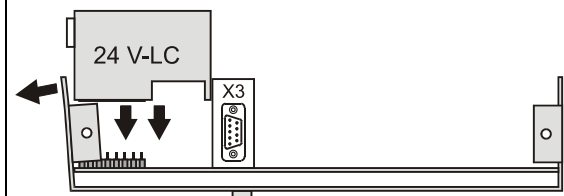

**Close housing,**

Bend tab back approx. 2 mm

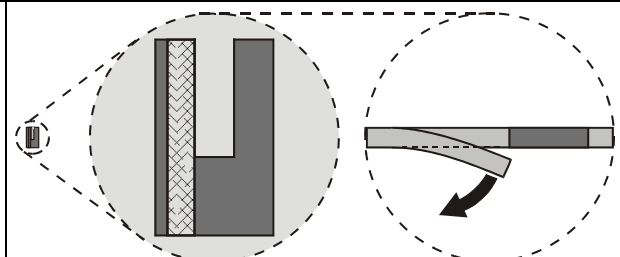

13. Result Table

| <b>Result Table</b>   |   |
|---|---|
| The result of actions (e.g., save parameter ( <b>A00=1</b> )) is indicated on the display. Possible results are listed below. |   |
| 0: Error free   | The data were transferred correctly.  |
| 1: Error!   | General error (e.g., while saving to the device without Paramodule)   |
| 3: Invalid data   | "Controlbox data record" contains invalid data. Write Controlbox again, and repeat the procedure.   |
| 5: OK (adjusted)  | Software version of "Controlbox data record" and inverter differ in several parameters. Confirm with the <b>[#]</b> key. Message does not affect functionality of the inverter.   |
| 6: OK (adjusted)  | Software version of "Controlbox data record" and inverter differ in several parameters. Confirm with the <b>[#]</b> key. Message does not affect functionality of the inverter.   |
| 9: BE encoder signal  | <b>F34=14</b> and <b>F35=15</b> must be set when control mode „vector control with 2-channel feedback“ has been selected with <b>B20=2</b> .  |
| 10: Limit   | Value outside the value range   |
| 11: $f(\text{BE}) > 80 \text{ kHz}$   | Only if <b>B20=2</b> and <b>B26=0</b> . Maximum frequency on BE exceeds permissible limit value of 80 kHz. $(n\text{-Max}/60) \times \text{incremental encoder} > 80 \text{ kHz}$ , or $(\text{C01}/60) \times \text{F36} > 80 \text{ kHz}$ .                       |
| 13: BE cw/ccw   | Programming <b>F31=14</b> and <b>F32=14</b> can be used to simulate the specification of the direction of rotation of inverters with software 3.2. The functions "direction of rotation," "halt," and "quick stop" may not be assigned to other BEs.                |
| 14: Canceled  | <ul style="list-style-type: none"> <li>Action canceled (e.g., due to removal of enable).</li> <li>The current exceeded the permissible maximum value (e.g., short circuit or ground fault) during "autotuning" or "phase test" (<b>B40</b>, <b>B41</b>).</li> </ul> |
| 15: R1 too high   | A stator resistance measured during "autotuning" ( <b>B41</b> ) was too high. Motor is circuited incorrectly. Motor cable is defective.   |
| 16: Phase fault U   | Error in phase U  |
| 17: Phase fault V   | Error in phase V  |
| 18: Phase fault W   | Error in phase W  |
| 19: Symmetry  | Error in symmetry of phases U, V and W. Deviation of a winding resistor by $\pm 10\%$ .   |

## 14. Operating States

### Operating States

The operating state is indicated on the display and can be queried under **E80** during fieldbus access.

|                       |  |
|-----------------------|--|
| 0: Ready              | Inverter is ready.   |
| 1: Clockwise          | Fixed positive speed   |
| 2: Counter-clockwise  | Fixed negative speed   |
| 3: Acceleration       | Acceleration procedure in progress (Accel)   |
| 4: Deceleration       | Deceleration procedure in progress (Decel)   |
| 5: Halt               | Halt command present   |
| 6: $n < n\text{-Min}$ | Reference value $< n\text{-Min}$ ( <b>C00</b> )  |
| 7: $n > n\text{-Max}$ | Reference value greater than minimum of <b>C01</b> and <b>E126</b> (via analog input or fieldbus)  |
| 8: Illegal direction  | Specified direction of rotation is not the permissible direction of rotation ( <b>C02</b> ).   |
| 9: Load start         | Load start is active ( <b>C21</b> , <b>C22</b> ).  |
| 10: Capturing         | Capturing is active.   |
| 11: Quick stop        | Quick stop is being performed.   |
| 12: Inhibited         | This state prevents the drive from starting up unintentionally. Effective for: <ul style="list-style-type: none"> <li>• Drive is turned on (power on) with enable=high (only if A34=0).</li> <li>• A fault is acknowledged with a low-high change in enable.</li> <li>• Opened load relay (no power and DC link below 130 V)</li> <li>• When the option board powers the basic device externally with 24 V (no network voltage)</li> <li>• When <b>A30=2:fieldbus</b> and the fieldbus sends an "inhibit voltage" control command, or the enable terminal becomes low, or a quick stop is concluded</li> </ul> |
| 13: Serial (X3)       | Parameter <b>A30=1</b> parameterized. Inverter is controlled by the PC via serial interface.   |
| 14: Enabled           | Only available with DRIVECOM profile. Bus connection.  |
| 15: Self test         | A self test is being performed on the inverter. During startup with ext. 24 V, "15:Self test" is indicated until power-on.   |
| 16: Fault             | The inverter's power pack is disabled.   |
| 17: Posi.active       | Position control is active. Waiting for a start command. Basic state of positioning control.   |
| 18: Moving <i>no.</i> | Processing a traversing job. Drive is moving. <i>No.</i> is the current process block ( <b>I82</b> ).  |
| 19: Delay <i>no.</i>  | For process block chaining with defined delay or for repetition of relative movements. During a stop between two sequential jobs, the signal "in position" is generated, but the display shows "delay."  |
| 20: Wait <i>no.</i>   | For process block chaining with defined manual start (i.e., wait for <i>posi.step</i> signal)  |
| 21: Referencing       | During reference point traversing  |
| 22: Tip               | During manual traversing   |
| 23: Interrupted       | After an interrupted process block (i.e., halt or quick stop) with the option of continuing with the <i>posi.step</i> signal. <i>Posi.step</i> is then used to move to the original destination position regardless of whether the drive has been moved in the meantime. See chap. 4.10. of POSI docu (441587).  |
| 24: Reference wait    | Wait for <i>posi.start</i> or <i>posi.step</i> signal to trigger reference point traversing after power on ( <b>I37=1</b> ).   |
| 25: Stop input        | Drive is positioned on stop input.   |
| 26: Parameter inhibit | During data transmission from PC to inverter, software on the PC deactivates the enable.   |

15. Faults / Events

| <b>Faults / Events</b>   |   |            |           |
|--|---|------------|-----------|
| When faults occur, the inverter is no longer able to control the drive and is disabled. An entry is made in the fault memory ( <b>E40/E41</b> ), and relay 1 (ready for operation) releases. If installed when the fault occurs, the Parabox is written automatically. Certain events (cf. last column of the table below) can be declared via FDS Tool as faults, messages, warnings or deactivate. |   |            |           |
|  |   | Auto Reset | FDS Tool* |
| 31: Short/ground   | The hardware overcurrent switch-off is active.<br>• Motor requires too much current from the inverter (e.g., interwinding fault or overload).   |            |           |
| 32: Short/gr. int.   | When the inverter is enabled, an internal check is performed. A short circuit triggers a fault.<br>• An internal device fault has occurred (e.g., IGBT modules are defective).  |            |           |
| 33: Overcurrent  | • Acceleration times too short. Lengthen ramps in group <b>D</b> .<br>• Check torque limits <b>C03 / C04</b> .<br>- Which torque limits are in effect? See chapter 9.2.<br>- Reduce torque limits <b>C03/C04</b> set to maximum value by approx. 10 %.<br>• Optimize parameter <b>C30</b> (ratio of the moments of inertia).<br>• With vector control ( <b>B20=2</b> ): encoder not connected correctly | √          |           |
| 34: Hardw. fault   | The non-volatile data memory (NOVRAM) is defective or software version is time-limited.   |            |           |
| 35: Watchdog   | Monitors the load and functions of the microprocessor<br>This malfunction may also be caused by EMC problems (e.g., shield of the motor cable or PE conductor not connected at all or connected incorrectly).   | √          |           |
| 36: High voltage   | DC-link voltage too high<br>• Power too high<br>• Reverse powering of the drive while braking (no brake resistor connected, brake chopper deactivated with <b>A20=0:inactive</b> or defective)<br>• Braking resistor with too low resistance value (overcurrent protection).  | √          |           |
| 38: tempDev.sens   | The temperature <b>E25</b> measured by the device sensor is greater than the limit value.<br>• Temperature of environment/switching cabinet is too high.  |            |           |
| 39: TempDev.i <sup>2</sup> t   | The i <sup>2</sup> t model calculated for the inverter is 100% of the thermal load.<br>• Inverter is overloaded (e.g., because motor is jammed or timing is too high).<br>• Timing frequency <b>B24</b> is too high.  |            |           |
| 40: Invalid data   | The data in non-volatile memory are incomplete (power was turned off during "A00 save values"). Load data record again to the device, or check the parameters in the menu and execute <b>A00</b> again.   |            |           |
| 41: Temp.motorTMP  | Excessive temperature indicated by the motor temperature sensor. Connection terminal X2.5 to X2.6.<br>• Motor is overloaded. Use external ventilation<br>• Temperature sensor not connected (if not present, jumper -> X2.5 to X2.6)  |            |           |
| 42: Temp.brakeRes  | The i <sup>2</sup> t model for the braking resistor reaches 100% thermal load.  |            | √         |
| 43: RV wire brk  | Only if the reference value is calculated with the reference value characteristic (reference value specification via analog input 1 or frequency reference value), and reference value monitoring is activated ( <b>D08=1</b> ).<br>• The reference value output is 5% less than the minimum permissible reference value ( <b>D05</b> ).  |            | √         |
| 44: Ext.fault  | Can be triggered by binary input or fieldbus ( <b>F31=12</b> )  |            |           |
| 45: OTempMot.i <sup>2</sup> t  | Motor overloaded  |            | √         |
| 46: Low voltage  | DC-link voltage is below the limit value set in <b>A35</b> .<br>• Drops in the power supply<br>• Failure of a phase with 3~ connection<br>• Fault is also triggered when option board is used (24 V external supply) when the power supply drops while the enable is active.<br>• Acceleration times are too short (ramps, <b>D</b> ..).  | √          | √         |
| 47: Device overl.  | The maximum torque permitted for static operation has been exceeded. The permissible torque is limited by parameters <b>C03</b> and <b>C04</b> and the possible torque limitation via analog input. See <b>F25=2</b> and chap. 9.2.   | √          | √         |

\* Events can be programmed with FDS Tool as messages, warnings or faults, or can be completely deactivated.

15. Faults / Events

**Faults / Events**

When faults occur, the inverter is no longer able to control the drive and is disabled. An entry is made in the fault memory (**E40/E41**), and relay 1 (ready for operation) releases. If installed when the fault occurs, the Parabox is written automatically. Certain events (cf. last column of the table below) can be declared via FDS Tool as faults, messages, warnings or not effective.

|                   |   | Auto Reset | FDS Tool* |
|-------------------|---|------------|-----------|
| 48: Accel.overl.  | Same as "47:Device overload" except for an acceleration procedure. M-Max 2 ( <b>C04</b> ) is permitted for the acceleration procedure with "cycle characteristic" startup ( <b>C20=2</b> ).   | √          | √         |
| 49: Decel.overl.  | Same as "47:Device overload" except there is a deceleration procedure   | √          | √         |
| 50: Operat.area   | The operating area defined under <b>C41</b> to <b>C46</b> has been exited. See also chap. 9.3.  | √          | √         |
| 51: Refused       | Only for positioning ( <b>C60=2</b> ). <i>Posi.start</i> or <i>posi.step</i> was not accepted and the RV-reached signal ("in position") is reset. <ul style="list-style-type: none"> <li>• Destination position is located outside software limit switches <b>I50</b> and <b>I51</b>.</li> <li>• In non-referenced status (<b>I86=0</b>), no absolute positions (e.g., <b>J11=1</b>) are traveled to.</li> <li>• The direction of rotation in the current process block is not the same as the permissible direction <b>I04</b>.</li> </ul> | √          | √         |
| 52: Communication | <ul style="list-style-type: none"> <li>• Fault during communication between inverter and FDS Tool during remote control via PC</li> <li>• Communication fault during fieldbus operation (Kommubox)</li> </ul>   | √          |           |
| 53: Stop input    | An end switch connected via BE input has been triggered.  |            |           |
| 55: OptionBoard   | Failure of the 24 V LC option board (not a malfunction if enable is deactivated). Only the failure of an already initialized module can be detected.  |            |           |

√ The events checked in the "FDS Tool" column can be parameterized with FDS Tool as messages, warnings or faults in the group **U..** protective functions.

**Acknowledgment of faults:**

- **Enable:** Change from low to high level on the enable input and then back to low. Always available.
-  **key** of Controlbox (only if **A31=1**).
- **Auto-reset** (only if **A32=1**).
- **Binary input** (**F31** to **F35=13**).

}  **Caution!**  
Drive starts up immediately!

Parameters **E40** and **E41** can be used to scan the last 10 faults (i.e., value 1 is the last fault). FDS Tool can then be used to indicate under "**S..** fault memory" many details on the last faults which occurred.

16. Block Circuit Diagram Reference Value Processing

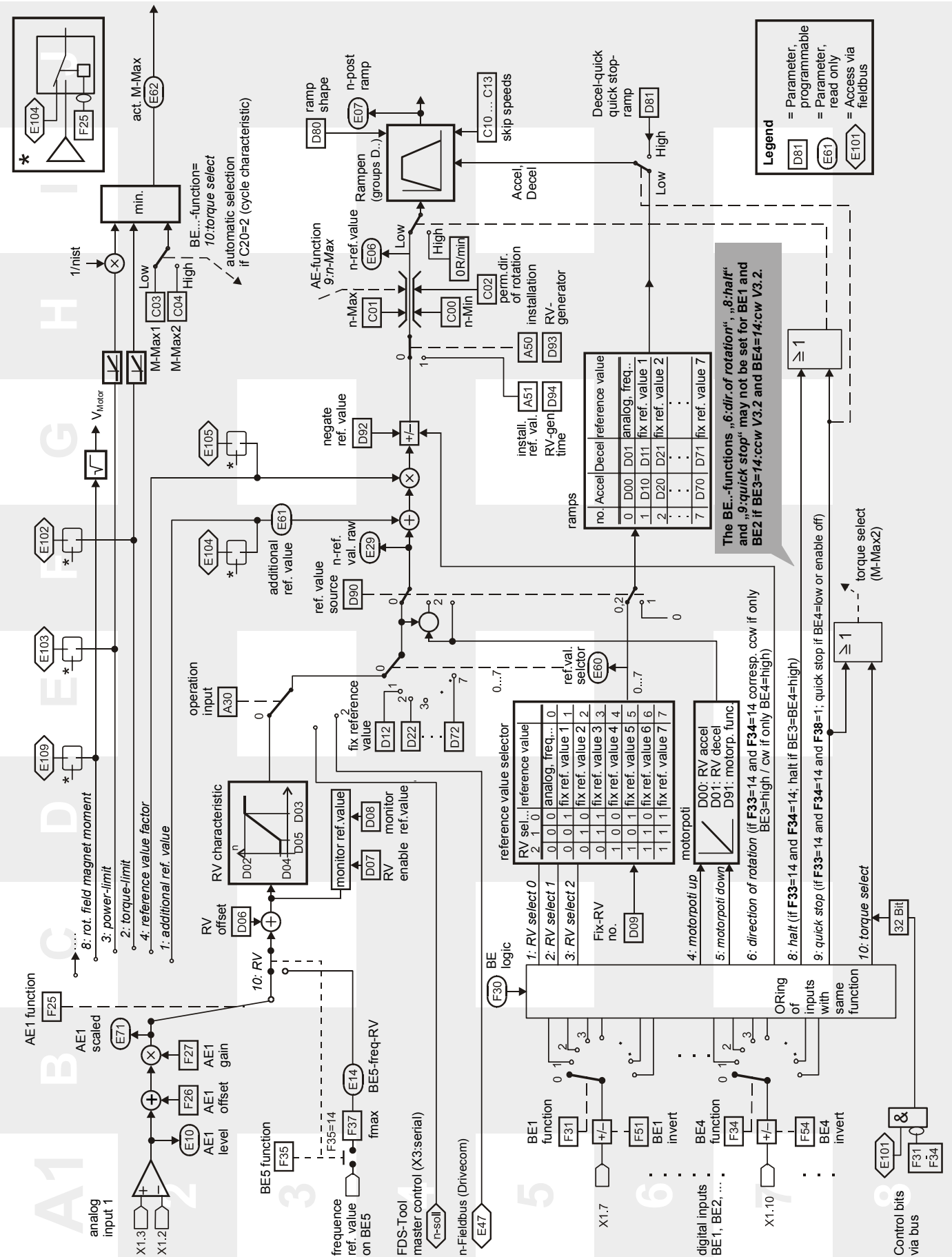







17. Accessories

**17.1 Accessories overview**

|   | Id. No. | Designation  | Remarks   |
|---|---------|--|---|
|    | 27355   | <p><b>Posi Upgrade module</b></p> <p>The Posi Upgrade module upgrades a complete, single-axis positioning controller. Particularly together with a fieldbus, this controller shows off its full range of powerful features.</p>  | Chap. 7.2 and Chap. 10  |
|    | 43673   | <p><b>Option board 24V-LC</b></p> <p>External 24 V power for inverter, encoder and fieldbus. Useful for applications with positioning control to avoid new reference traversing after an emergency off and with fieldbus so that parameterization and diagnosis can also be performed without power.</p> | Chap. 11, parameter <b>E54</b>  |
|   | 40021   | <p><b>CAN bus, Kommubox</b></p> <p>Interface module for CAN bus with CANopen profile CIA/DS-301.</p>   | CAN bus documentation:<br>Publ. no. 441532 (german)<br>Publ. no. 441562 (english)   |
|  | 40022   | <p><b>Profibus-DP, Kommubox</b></p> <p>Interface module for Profibus-DP.</p>   | Profibus-DP documentation:<br>Publ. no. 441525 (german)<br>Publ. no. 441535 (english)   |
|  | 44087   | <p><b>CD THE WORLD OF ELECTRONICS</b></p> <p>This CD-ROM contains:</p> <ul style="list-style-type: none"> <li>• Sample applications,</li> <li>• Documentation,</li> <li>• FDS-Tool (PC programm for programming, operation and observation of the inverters)</li> <li>• Fieldbus datas</li> </ul>        | Download from:<br><a href="http://www.stoeber.de">http://www.stoeber.de</a><br><br>FDS-Tool documentation:<br>Publ. no. 441349 (german)<br>Publ. no. 441409 (english) |



17. Accessories

|   | Id. No. | Designation  | Remarks   |
|---|---------|--|---|
|     | 41488   | <p><b>Connection cable G3</b><br/>PC &lt;-&gt; FDS connection cable with 9-pin sub D plug connector, plug connector/socket</p>   | Chap. 9.9   |
|   | 42224   | <p><b>External operator, CONTROLBOX</b><br/>Operating unit for parameterization and operation of the inverters. Connecting lead (2 m ) is included in the scope of supply.</p> | <p>Controlbox documentation:<br/>Publ. no. 441445 (german)<br/>Publ. no. 441479 (english)<br/>Publ. no. 441651 (french)</p> |
|  | 42225   | <p><b>External operator, in a built-in DIN housing 96x96 mm</b><br/>see above<br/>Protection rating IP54</p>   |   |
|   | 42558   | <p><b>PC adapter with power pack</b><br/>Power supply for controlbox for direct data exchange with the PC.</p>   | Chap. 7   |
|   | 42583   | <p><b>PC adapter with PS/2 connector</b><br/>Power supply via PS/2 interface for controlbox for direct data exchange with the laptop.</p>                                      | Chap. 7   |

17. Accessories

**17.2 Braking resistor**

**17.2.1 Allocation of braking resistor to FAS 4000**

| Type     | Id. No. | FZM                      |                          |                          |                          | FZMU  | VHPR  |                            | VHPR                       |
|----------|---------|--------------------------|--------------------------|--------------------------|--------------------------|--|--|----------------------------|----------------------------|
|          |         | 135x35<br>100 W<br>300 Ω | 200x35<br>150 W<br>300 Ω | 200x35<br>150 W<br>100 Ω | 330x35<br>250 W<br>300 Ω | 400x65<br>600 W<br>100 Ω   | VHPR150V<br>150 W<br>300 Ω   | VHPR150V<br>150 W<br>100 Ω | VHPR600V<br>600 W<br>100 Ω |
|          |         | 40374                    | 40375                    | 25863                    | 40376                    | 49010  | 45972  | 45973                      | 44316                      |
| FAS 4008 | 43665   | -                        | -                        | X                        | -                        | -  | -  | X                          | -                          |
| FAS 4016 | 43666   | -                        | -                        | X                        | -                        | -  | -  | X                          | -                          |
| FAS 4009 | 43667   | X                        | X                        | -                        | X                        | -  | X  | -                          | -                          |
| FAS 4014 | 43668   | X                        | X                        | -                        | X                        | -  | X  | -                          | -                          |
| FAS 4020 | 43676   | X                        | X                        | -                        | X                        | -  | X  | -                          | -                          |
| FAS 4028 | 43669   | X                        | X                        | -                        | X                        | -  | X  | -                          | -                          |
| FAS 4038 | 43670   | -                        | -                        | X                        | -                        | X  | -  | X                          | X                          |
| FAS 4050 | 43813   | -                        | -                        | X                        | -                        | X  | -  | X                          | X                          |

**17.2.2 Braking resistor FZM(U) / FZZM (dimensions)**

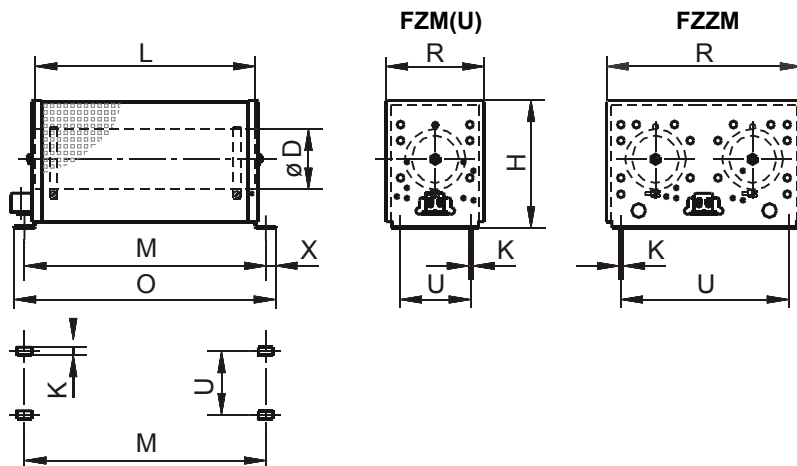

| Type        | FZM 135x35 | FZM 200x35 | FZM 330x35 | FZMU 400x65 | FZZM 400x65 |
|-------------|------------|------------|------------|-------------|-------------|
| L x D       | 135 x 35   | 200 x 35   | 330 x 35   | 400 x 65    | 400 x 65    |
| H           | 77         | 77         | 77         | 120         | 120         |
| K           | 4.5 x 9    | 4.5 x 9    | 4.5 x 9    | 6.5 x 12    | 6.5 x 12    |
| M           | 157        | 222        | 352        | 430         | 426         |
| O           | 172        | 237        | 367        | 485         | 446         |
| R           | 66         | 66         | 66         | 92          | 185         |
| U           | 44         | 44         | 44         | 64          | 150         |
| X           | 7          | 7          | 7          | 10          | 10          |
| Weight [kg] | 0.6        | 0.7        | 1.1        | 2.2         | 4.2         |

[dimensions in mm]

17. Accessories

**17.2.3 Braking resistor VHPR (dimensions)**

| Type       | VHPR150V<br>150 W<br>300 Ω | VHPR150V<br>150 W<br>100 Ω | VHPR600V<br>600 W<br>100 Ω |
|------------|----------------------------|----------------------------|----------------------------|
| L          | 212                        | 212                        | 420                        |
| C          | 193                        | 193                        | 400                        |
| B          | 40                         | 40                         | 60                         |
| A          | 21                         | 21                         | 31                         |
| D          | 4.3                        | 4.3                        | 5.3                        |
| E          | 8                          | 8                          | 11.5                       |
| F          | 13                         | 13                         | 19.5                       |
| Weight [g] | approx. 310                | approx. 310                | approx. 1300               |

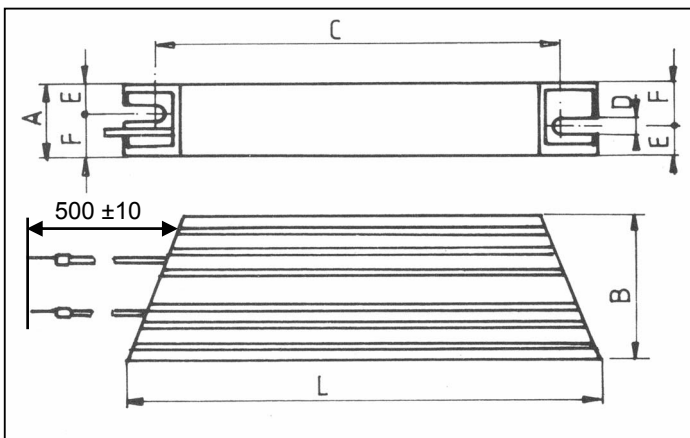

[dimensions in mm]

**17.3 Output reactor**

**17.3.1 Allocation of output derating to FAS 4000**

| Type     | Id. No. | RU 775 / 5 A <sub>eff</sub> | RU 774 / 13 A <sub>eff</sub> |
|----------|---------|-----------------------------|------------------------------|
|          |         | 28206                       | 28207                        |
| FAS 4008 | 43665   | X                           | -                            |
| FAS 4016 | 43666   | X                           | -                            |
| FAS 4009 | 43667   | X                           | -                            |
| FAS 4014 | 43668   | X                           | -                            |
| FAS 4020 | 43676   | -                           | X                            |
| FAS 4028 | 43669   | -                           | X                            |
| FAS 4038 | 43670   | -                           | X                            |
| FAS 4050 | 43813   | -                           | X                            |

**17.3.2 Output reactor RU (dimensions)**

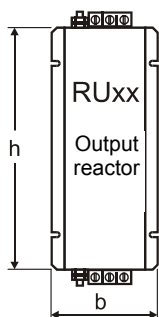

| Type                    | RU 775 / 5 A <sub>eff</sub>                               | RU 774 / 13 A <sub>eff</sub> |
|-------------------------|---|------------------------------|
| W x H x D (in mm)       | 70 x 160 x 55   | 105 x 240 x 80               |
| Max. line cross section | 6 mm <sup>2</sup> (rigid) or 4 mm <sup>2</sup> (flexible) |                              |



---

Additional information under:  
**<http://www.stoeber.de>**

## Posi Upgrade Module

---

The Posi Upgrade module makes it possible to upgrade to a complete single-axis positioning control. Particularly when used with a fieldbus, this controller shows off its full range of powerful features.

- Destination travel to precise increment in VC mode
- Continuous position control with following error monitoring (VC)
- In control mode SLVC: Position control can also be used without encoder.
- Positions in 8 process blocks can be programmed.
- Rotary axis function of gear transmission with specification of both axle numbers
- Parameterization with units specified (e.g., in degrees and mm)
- Reference traversing with several modes
- Manual operation (inching)
- Teach in function
- Speed override via analog input
- Hardware and software proximity switch



## STÖBER . . . The Drive for Your Automation



**STÖBER ANTRIEBSTECHNIK**  
GmbH + Co. KG

GERMANY  
Kieselbronner Strasse 12 · 75177 Pforzheim  
Postfach 910103 · 75091 Pforzheim  
Fon +49 (0) 7231 582-0, Fax +49 (0) 7231 582-1000  
Internet: <http://www.stoeber.de> / e-Mail: [mail@stoeber.de](mailto:mail@stoeber.de)

Presented by: